

User Manual
AC Servo Controller YukonDrive®
PROFIBUS
PROFINET



Harmonic
Drive AG



QUICKLINK
www.harmonicdrive.de/1100

...just move it!

This document describes the functionality of the following devices:

YukonDrive®-10xx-xEx-xx (PROFIBUS)

YukonDrive®-10xx-xFx-xx (PROFINET)

Content

1	General	4
1.1	Description of Safety Alert Symbols.....	5
1.2	Disclaimer and Copyright	5
2	Safety and Installation Instructions	6
2.1	Hazards	6
2.2	Intended Purpose	7
2.3	Non Intended Purpose	8
2.4	Declaration of Conformity.....	8
3	Introduction	9
3.1	System requirements	9
3.2	Further documentation.....	9
4	Commissioning	10
4.1	PROFIBUS.....	10
4.1.1	Connections and status indicators	10
4.1.2	Pin assignment of the D-Sub socket.....	11
4.1.3	Specification of the PROFIBUS cable	12
4.1.4	Bus termination	13
4.1.5	PROFIBUS address setting.....	14
4.1.6	PROFIBUS option card displays	15
4.1.7	GSD file (PROFIBUS).....	16
4.2	PROFINET.....	16
4.2.1	Connection.....	16
4.2.2	Pin assignment of the RJ-45 socket.....	17
4.2.3	Specification of the PROFINET cable	18
4.2.4	Meanings of LEDs	18
4.2.5	PROFINET option card displays.....	19
4.2.6	GSDML file (PROFINET)	19
5	Cyclic data transfer – DPVO	20
5.1	Parameter process data objects (PPO).....	20
5.1.1	Standard „PROFIdrive“ telegrams.....	21
5.1.2	User-specific PPOs	23
5.1.3	Parameter channel PKW.....	27
5.2	Monitoring.....	30
5.2.1	Watchdog	30
5.2.2	Sign of Life	30
6	Acyclic data transfer-DPV1	32
6.1	Parameter access PROFIBUS	32
6.1.1	Parameter access PROFINET	38
6.1.2	„Base Mode Parameter Access“ data format.....	38
6.2	Examples of request and response telegrams.....	42

7	Operation modes PROFIDRIVE	45
7.1	Operation modes	45
7.1.1	Speed control circuit and associated control parameters	46
7.2	Drive state machine	48
7.3	Jog mode	51
7.3.1	Jog mode manufacturer-specific	51
7.3.2	Jog mode conforming to profile	51
7.3.3	Jog mode reference parameters	51
7.4	Speed control (application class 1)	52
7.4.1	Master control word	53
7.4.2	Drive status word	55
7.5	Position control (application class 3)	57
7.5.1	Position control circuit and associated control parameters	58
7.6	Homing	60
7.6.1	Drive-controlled homing	60
7.6.2	Homing velocity	60
7.6.3	Homing acceleration	60
7.6.4	Zero point offset	60
7.6.5	Homing method	61
7.6.6	Reference cam, limit switch	61
8	Examples of commissioning	62
8.1	Position control with PPO 5	62
8.2	Control based homing	64
8.3	Conversion of reference and actual values via the factor group parameters	64
8.4	Examples for setting the user factor group	66
8.5	Speed control with PPO 2	66
8.5.1	Speed input	68
8.6	Mappable parameters	69
9	PROFIBUS / PROFINET parameters	70
10	Glossary	72
10.1	General	72
10.2	Technical Data	75

1. General

About this documentation

This document contains safety instructions, technical data and operation rules for products of Harmonic Drive AG. The documentation is aimed at planners, project engineers, commissioning engineers and machine manufacturers, offering support during selection and calculation of the servo actuators, servo motors and accessories.

Rules for storage

Please keep this document for the entire life of the product, up to its disposal. Please hand over the documentation when re-selling the product.

Additional documentation

For the configuration of drive systems using the products of Harmonic Drive AG, you may require additional documents. Documentation is provided for all products offered by Harmonic Drive AG and can be found in pdf format on the website.

www.harmonicdrive.de

Third-party systems

Documentation for parts supplied by third party suppliers, associated with Harmonic Drive® components, is not included in our standard documentation and should be requested directly from the manufacturers.





Before commissioning products from Harmonic Drive AG with servo drives, we advise you to obtain the relevant documents for each device.

Your feedback

Your experiences are important to us. Please send suggestions and comments about the products and documentation to:

Harmonic Drive AG
Marketing and Communications
Hoenbergstraße 14
65555 Limburg / Lahn
Germany
E-Mail: info@harmonicdrive.de

1.1 Description of Safety Alert Symbols

Symbol	Meaning
	Indicates an imminent hazardous situation. If this is not avoided, death or serious injury could occur.
	Indicates a possible hazard. Care should be taken or death or serious injury may result.
	Indicates a possible hazard. Care should be taken or slight or minor injury may result.
	Describes a possibly harmful situation. Care should be taken to avoid damage to the system and surroundings.
	This is not a safety symbol. This symbol indicates important information.
	Warning of a general hazard. The type of hazard is determined by the specific warning text.
	Warning of dangerous electrical voltage and its effects.
	Beware of hot surfaces.
	Beware of suspended loads.
	Precautions when handling electrostatic sensitive components.

1.2 Disclaimer and Copyright

The contents, images and graphics contained in this document are protected by copyright. In addition to the copyright, logos, fonts, company and product names can also be protected by brand law or trademark law. The use of text, extracts or graphics requires the permission of the publisher or rights holder.

We have checked the contents of this document. Since errors cannot be ruled out entirely, we do not accept liability for mistakes which may have occurred. Notification of any mistake or suggestions for improvements will be gratefully received and any necessary correction will be included in subsequent editions.

2. Safety and Installation Instructions

Please take note of the information and instructions in this document. Specially designed models may differ in technical detail. If in doubt, we strongly recommend that you contact the manufacturer, giving the type designation and serial number for clarification.

2.1 Hazards



Electric servo actuators and motors have dangerous live and rotating parts. All work during connection, operation, repair and disposal must be carried out by qualified personnel as described in the standards EN50110-1 and IEC 60364! Before starting any work, and especially before opening covers, the actuator must be properly isolated. In addition to the main circuits, the user also has to pay attention to any auxiliary circuits.

Observing the five safety rules:

- Disconnect mains
- Prevent reconnection
- Test for absence of harmful voltages
- Ground and short circuit
- Cover or close off nearby live parts

The measures taken above must only be withdrawn when the work has been completed and the device is fully assembled. Improper handling can cause damage to persons and property. The respective national, local and factory specific regulations must be adhered to.



The surface temperature of gears, motors and actuators can exceed 55 degrees Celsius. The hot surfaces should not be touched.

ADVICE

Cables must not come into direct contact with hot surfaces.



DANGER

Electric, magnetic and electromagnetic fields are dangerous, in particular for persons with pacemakers, implants or similar. Vulnerable groups must not be in the immediate vicinity of the products themselves.



DANGER

Built-in holding brakes alone are not functional safe. Particularly with unsupported vertical axes, the functional safety and security can only be achieved with additional, external mechanical brakes.



WARNING

The successful and safe operation of gears, servo actuators and motors requires proper transport, storage and assembly as well as correct operation and maintenance.



ADVICE

Use suitable lifting equipment to move and lift gears, servo actuators and motors with a weight > 20 kg.

INFORMATION

Special versions of products may differ in the specification from the standard. Further applicable data from data sheets, catalogues and offers of the special version have to be considered.

2.2 Intended Purpose

The Harmonic Drive® servo actuators and motors are intended for industrial or commercial applications. They comply with the relevant parts of the harmonised EN 60034 standards series. If in special cases, for example in non-industrial or non-commercial applications, more stringent requirements are demanded, these requirements are to be achieved by the customer.

Typical areas of application are robotics and handling, machine tools, packaging and food machines and similar machines.

The servo actuators and motors may only be operated within the operating ranges and environmental conditions shown in the documentation (altitude, degree of protection, temperature range etc).

Before plant and machinery which have Harmonic Drive® servo actuators and motors built into them are commissioned, the compliance must be established with the Machinery Directive, Low Voltage Directive and EMC guidelines.

Plant and machinery with inverter driven motors must satisfy the protection requirements in the EMC guidelines. It is the responsibility of the installer to ensure that installation is undertaken correctly.

Signal and power lines must be shielded. The EMC instructions from the inverter manufacturer must be observed in order that installation meets the EMC regulations.

2.3 Non Intended Purpose

The use of servo actuators and motors outside the areas of application mentioned above or, inter alia, other than in the operating areas or environmental conditions described in the documentation is considered as non-intended purpose.

The following areas of application are, inter alia, those considered as non-intended purpose:

- Aerospace
- Areas at risk of explosion
- Machines specially constructed or used for a nuclear purpose whose breakdown might lead to the emission of radio-activity
- Vacuum
- Machines for domestic use
- Medical equipment which comes into direct contact with the human body
- Machines or equipment for transporting or lifting people
- Special devices for use in annual markets or leisure parks

2.4 Declaration of Conformity

The Harmonic Drive® servo actuators and motors described in the engineering data comply with the Low Voltage Directive. A copy of the EC conformity declaration is supplied in the appendix.

In accordance with the Machinery Directive, Harmonic Drive® servo actuators and servo motors are electrical equipment for the use within certain voltage limits as covered by the Low Voltage Directive and thus excluded from the scope of the Machinery Directive. Commissioning is prohibited until the final product conforms to the Machinery Directive.

[3. Introduction](#)

PROFIBUS based on standards and its modular interfaces. Thanks to its use of a single standardised, non-application-dependent communication protocol, PROFIBUS provides solutions for the process industry as well as in a wide range of motion control applications.

PROFINET permits enhanced system-wide connectivity, adding to tried and proven PROFIBUS technology for applications specifying fast data communication in combination with industrial IT functionality. Thanks to its Ethernet-based communication, PROFINET meets a wide range of requirements, from data-intensive parameter assignments to synchronised data transfer. Communication for all applications is routed through just one cable, whether for a simple control task or for highly dynamic motion control of drive axes. TCP/IP-based communication in the PROFINET network enabling extensive system diagnostics in a control station or over the Internet is implemented in parallel with real-time communication.

[3.1 System requirements](#)

- PROFIBUS/PROFINET configuration program installed.
- PROFIBUS/PROFINET device description file for corresponding field device installed.

[3.2 Further documentation](#)

- Instructions for commissioning the drive device
- PROFIBUS user organisation „PROFIdrive - PROFIdrive Technology for PROFIBUS and PROFINET“ Version 4.1, May 2006, Order no. 3.172
- PROFIBUS User Organisation: „Profile Guidelines Part 1: Identification & Maintenance Functions, 1.2, Oct 2009, Order No. 3.502“

4. Commissioning

4.1 PROFIBUS

4.1.1 Connections and status indicators

The connections and status indicators of the PROFIBUS interface are shown in table 10.1. LEDs H1, H2, H3 act as status indicators. The PROFIBUS cable is connected to the D-Sub socket X14.

Table 10.1 Option card PROFIBUS

Front panel	No.	Comments
	H1	Status indicator LED (yellow)
	H2	Status indicator LED (red)
	H3	Status indicator LED (green)
	X14	PROFIBUS cable connection

4.1.2 Pin assignment of the D-Sub socket

PROFIBUS is connected via a nine-pin sub-D plug connector. The pin assignment is shown in the diagram below and described in the following table.

Illustration 11.1 Pin assignment of D-SUB connector

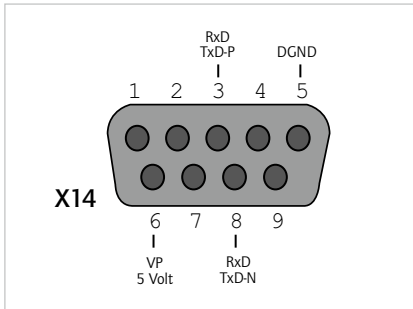

Table 11.2 Description of pin assignment

PIN	RS-485	Signal	Description
1		SHIELD	Earthed shield
2		RP	Reserved for power supply via bus
3	B/B' (rot)	RxD / TxD-P	Send and receive data (+)
4		CNTR-P	Control signal for repeater (+)
5	C/C'	DGND	Data reference potential and power supply to terminating resistor (-)
6		VP	Power supply for terminating resistor (+)
7		RP	Reserved for power supply via bus
8	A/A' (grün)	RxD / TxD-N	Send and receive data (-)
9		CNTR-N	Control signal for repeater (-)

The pin assignments highlighted in table 2.2 are necessary from the user's viewpoint. The control signals used for the repeaters are optional, and the power supply for the terminating resistors is provided by the device.

4.1.3 Specification of the PROFIBUS cable

The following hardware is recommended for wiring:

Table 12.1 Recommended PROFIBUS connector

PROFIBUS D-Sub bus connector	
Siemens order number	6XV1 830-0EH10
Siemens article description	PB FC RS485 PLUG 180, AXIAL CABLE OUTLET

Table 12.2 Recommended PROFIBUS cable

PROFIBUS cable	
Siemens order number	6GK1 500-0FC10
Siemens article description	SIMATIC NET, PB FC STANDARD CABLE GP, 2-WIRE, SHIELDED

4.1.4 Bus termination

If the drive controller is initially at the end of the bus system, a plug with an integral terminating resistor R_t should be used. In addition to the cable terminating resistor in accordance with the EIA-RS-485 standard, a pull-down resistor R_d against the data reference potential DGND and a pull-up resistor R_u against VP are provided. This ensures a defined no-load potential of 1.1 Volt between pins 3 and 8. In a made-up PROFIBUS cable these resistors are all incorporated as standard in the PROFIBUS plug and the terminating resistor can be activated using a switch on the PROFIBUS plug. The following figure shows a Sub-D 9-pin plug bus termination.

Illustration 13.3 Sub-D 9-pin plug bus termination

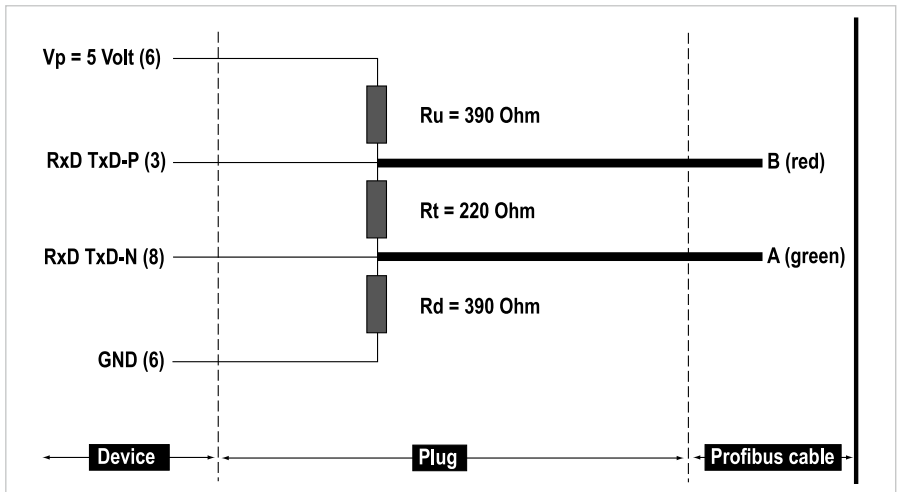

4.1.5 PROFIBUS address setting

The device address can be set via parameter 918 (COM_DP_Address) (decimal). The new device address will be valid after a 24 VDC OFF / ON cycle. The bus address can also be set via the console on the device (hexadecimal), refer to the YukonDrive® Operating Manual.

Select the mode of addressing

Table 14.1

1. Bus address parameter P-918	By way of bus address parameter P-918-COM_DP_Address a valid decimal address between 0 and 125 is set.
2. Setting via device console	A valid hexadecimal address between 0 and 125 is set using the device console on the submenu „Fb“. The preset value is written to bus address parameter P-918. Instructions for use of the device console are given in the YukonDrive® Operation Manual.

NOTE

All setting modes require the device to be restarted in order to activate the new address.

The following functions and displays are available:

- **Display of device state**
The device state is displayed when the control supply is switched on. If no input is made via the console for 60 seconds, the display switches back to the device state.
- **Display of device error state**
If a device error occurs the display immediately switches to show the error code.
- **Parameter setting (display „PA“)**
Reset device parameters to their factory setting
- **Ethernet IP address setting (display „IP“)**
Set Ethernet IP address and subnet mask
- **Field bus settings (display „Fb“)**
Set field bus address for example

4.1.6 PROFIBUS option card displays

Three LEDs are mounted on the PROFIBUS option card indicating the current operating status of the module. The following tables set out the operating states of the PROFIBUS option card based on the various illumination sequences.

Table 15.1 Self-test during diagnostics







LED 3, green	LED 2, red	Status
		Reset (after power on)
		ASIC RAM test and initialisation
		End of ASIC RAM test and initialisation

Table 15.2 Operational diagnostics

















LED 3, green	LED 2, red	Status
		Seeking baud rate after power on without bus connection
		Seeking baud rate after bus connection has already been made
		Waiting for parameterisation data
		Communication: Data exchange without acyclic master class 2 connection. Yellow LED lit.
		Communication: Data exchange „clear state“
		Incorrect parameterisation data
		Incorrect configuration data
		Communication: Data exchange with acyclic master class 2 connection

Table 15.3 Data exchange

LED 1, yellow	Status
	Device is exchanging data

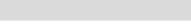
4.1.7 GSD file (PROFIBUS)

The device master data file contains the summary of the device features in a standardised form. The device features include the device name, the bus timing, the available extended services and the selectable modules (telegram types). In order to use the various telegram types, the GSD file must be integrated in the configuration phase of the PROFIBUS network. As well as the standard „Profidrive“ profile, this file also contains manufacturer-specific telegram types.

4.2 PROFINET

4.2.1 Connections

The connections of the PROFINET interface are shown in table 16.1. LEDs H17, H16 act as status indicators. The PROFINET cable is connected to the RJ 45 sockets X47/X48. The two PROFINET connecting sockets are freely configurable in their communication direction.

The PROFINET interface features a 2-port Multiport PHY (Physical Layer Transceiver) supporting the following functionality:

- Autonegotiation (automatic detection of the functionality of the opposite interface)
- Auto Crossing (no cross-over cables are required, so through-going wiring is assured)
- Auto Polarity (the polarity of the Receive cable is automatically adjusted in the event of a wiring error (RecvData+ and RecvData-))

Table 16.1 PROFINET option card

Front panel	No.	Comments
 <p>YukonDrive®</p>	H17	Status indicator LED (green)
	H16	Status indicator LED (red)
	X47/X48	PROFINET cable connection

4.2.2 Pin assignment of the RJ-45 socket

The contacting of eight-pin RJ45 sockets is subject to the EIA/TIA-568A/B standards. Table 171 below shows the pin assignment with the corresponding colour code for the EIA/TIA-568B standard.

The two standards differ only in that the two wire pairs 2 and 3 are interchanged.

Table 171 Pin assignment of the RJ-45 socket

Pin	Colour	Cable wire pair	Function
1	white/orange	2	TxData +
2	orange	2	TxData -
3	white/green	3	RecvData +
4	blue	1	Unused
5	white/blue	1	Unused
6	green	3	RecvData -
7	white/brown	4	Unused
8	brown	4	Unused

Illustration 17.2 RJ-45 socket

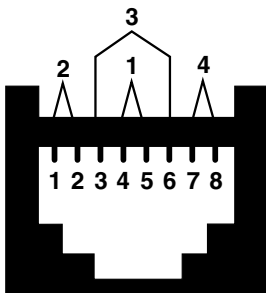

4.2.3 Specification of the PROFINET cable

The following hardware is recommended for wiring:

Table 18.1 Recommended PROFINET connector

PROFINET RJ 45 connector	
Siemens order number	6GK1901-1BB10-2AA0
Siemens article description	IE FC RJ45 PLUG 180 2X2, RJ45 CONNECTOR (10/100MBIT/5) WITH ROBUST METAL HOUSING & FC CONNECTION

Table 18.2 Recommended PROFINET cable

PROFINET cable	
Siemens order number	6XV1840-2AH10
Siemens article description	SIMATIC NET, IE FC TP STANDARD CABLE, GP 2X2 (PROFINET TYP A)

4.2.4 Meanings of LEDs

The two LEDs at the RJ-45 sockets have the following meanings

Table 18.3 Meanings of LEDs

LED	Function	Meaning
grün	Link / Activity	Off = no link ⇒ No link to another device
		On = Link ⇒ Linked to another device, no data exchange
		Blinking = Activity ⇒ Data exchange active
gelb	RUN	Off = Initialisation ⇒ Device in initialisation phase
		Blinking = Pre-Operational ⇒ Device in pre-operational phase
		Single Flash = Safe-Operational ⇒ Device in safe operational phase
		On = Operational ⇒ Device operational

4.2.5 PROFINET option card displays

Two LEDs are mounted on the PROFINET option card indicating the current operating status of the module. The following tables set out the operating states of the PROFINET option card based on the various illumination sequences.

Table 19.1 Self-test during diagnostics











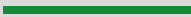

LED H1, green	LED H2, red	Status
		Reset (after power on)
		PROFINET test and initialisation
		End of PROFINET test and initialisation

Table 19.2 Operational diagnostics

LED H1, green	LED H2, red	Status
		PROFINET ready, no cyclic data exchange with PROFINET master
		PROFINET ready, cyclic data exchange with PROFINET master taking place
		PROFINET software being loaded
		PROFINET master flash function. 3 seconds flashing, 3 seconds lit steadily

4.2.6 GSDML file (PROFINET)

Description of file name

- File name: GSDML-Vx.xx-HD-YukonDrive®-date.xml
- Vx.xx : GSDML version
- Date: Date of creation of the GSDML file

Example: GSDML-V2.3-HD-YukonDrive®-20140625.xml

NOTE

The GSDML file contains the data for the YukonDrive® (DAP3). The required DAP (Data Access Point) must be selected during configuration. The GSDML file is available for downloading from the website and is included in the firmware package for the relevant device.

5. Cyclic data transfer - DPV0

5.1 Parameter process data objects (PPOs)

Communication between a class 1 master and the YukonDrive® controller is essentially established in three phases. Firstly the YukonDrive® is parameterised with the current bus parameters, monitoring times and drive-specific parameters (phase 1). In the configuration phase a configuration sent by the master is compared with the actual YukonDrive® configuration (phase 2). Once these two phases have been completed successfully, the cyclic user data traffic starts (phase 3).

The various telegram types (parameter process data objects - PPOs) are made available in the GSD file. These PPOs form the basis of the configuration phase. The project engineer knows from the GSD file how many bytes are required for the input and output data for PROFIBUS communication between the master and the drive controller and can use this information to make settings in a configuration tool. As well as the standard telegrams in accordance with the „PROFIdrive“ profile, there are additionally user-specific telegram types. In addition to the process data channel PZD, some user-specific telegrams have a parameter channel PKW.

5.1.1 Standard „PROFIdrive“ telegrams

The table below firstly lists the standard PROFIdrive telegrams supported by the drive controller. The following table explains the abbreviations assigned in the standard telegrams to specific process data channels. The process data channel (abbreviated as PZD) is grouped word-by-word.

Table 21.1 Abbreviation

Abbreviation	Designation	Number of words
STW1	Control word 1	1
STW2	Control word 2	1
ZSW1	Status word 1	1
ZSW2	Status word 2	1
NSOLL_A	Rotation speed reference	1
NIST_A	Actual rotation speed	1
SATZANW	Set selection (from driving set table)	1
AKTSATZ	Current set selection (from driving set table)	1
XSOLL_A	Reference position	2
XIST_A	Actual position	2
TARPOS_A	Reference target position	2
VELOCITY_A	Reference velocity	2
E_DIGITAL	Input	1
A_DIGITAL	Output	1

Standard telegram 1 is a defined telegram type for speed control. It consists of two input words and two output words as shown in the following table.

Table 21.2 Standard telegram 1

PZD number	1	2
Reference values	STW1	NSOLL_A
PZD number	1	2
Actual values	ZSW1	NIST_A

Standard telegram 7 is a defined telegram type for driving set selection. There are a total of 16 driving sets available for selection in the drive. This telegram type consists of two input words and two output words as shown in the following table.

Table 22.1 Standard telegram 7

PZD number	1	2
Reference values	STW1	SATZANW
PZD number	1	2
Actual values	ZSW1	AKTSATZ

Standard telegram 8 is a defined telegram type for positioning with the option to preset a positioning velocity. It consists of five input words and five output words as shown in the following table.

Table 22.2 Standard telegram 8

PZD number	1	2	3	4	5
Reference values	STW1	XSOLL_A		STW2	NSOLL_A
PZD number	1	2	3	4	5
Actual values	ZSW1	XIST_A		ZSW2	NIST_A

Standard telegram 9 is a defined telegram type for positioning. It consists of six input words and five output words as shown in the following table.

Table 22.3 Standard telegram 9

PZD number	1	2	3	4	5	6
Reference values	STW1	TARPOS_A		STW2	VELOCITY_A	
PZD number	1	2	3	4	5	
Actual values	ZSW1	XIST_A		ZSW2	NIST_A	

Every standard telegram in the device is described in the GSD or GSDML file as appropriate by a configuration identifier (ID) based on the PROFIdrive profile. The following table lists these identifiers for the selected standard telegrams.

Table 22.4 Identifiers

Telegram type	PROFIBUS		PROFINET	
	Data range	Identifier (ID)	Module-ID	IRT-module-ID
Standard telegram 1	2 output words and 2 input words	0xC3 0xC1 0xC1 0xFD 0x00 0x01	0x01	0x0101
Standard telegram 7	2 output words and 2 input words	0xC3 0xC1 0xC1 0xFD 0x00 0x07	0x07	0x0107
Standard telegram 8	5 output words and 5 input words	0xC3 0xC4 0xC4 0xFD 0x00 0x08	0x08	0x0108
Standard telegram 9	6 output words and 5 input words	0xC3 0xC5 0xC4 0xFD 0x00 0x09	0x09	0x0109

5.1.2 User-specific PPOs

As well as the supported standard telegrams, there are additional user-specific parameter process data objects (PPOs). The following PPOs are also transmitted cyclically and in addition to the process data channel PZD in some instances contain a parameter channel PKW enabling access to the drive parameter values.

Table 23.1 User-specific parameter process data objects

No.	PPO	PKW				PZD										
		PKE	IND	PKW 1	PKW 2	STW/ZSW	SOLL/IST	-	-	-	-	-	-	-	-	-
1	1	PKE	IND	PKW 1	PKW 2	STW/ZSW	SOLL/IST	-	-	-	-	-	-	-	-	-
2	2	PKE	IND	PKW 1	PKW 2	STW/ZSW	SOLL/IST	PZD 3	PZD 4	PZD 5	PZD 6	-	-	-	-	
3	3*	-	-	-	-	STW/ZSW	SOLL/IST	-	-	-	-	-	-	-	-	
4	4	-	-	-	-	STW/ZSW	SOLL/IST	PZD 3	PZD 4	PZD 5	PZD 6	-	-	-	-	
5	5	PKE	IND	PKW 1	PKW 2	STW/ZSW	SOLL/IST	PZD 3	PZD 4	PZD 5	PZD 6	PZD 7	PZD 8	PZD 9	PZD 10	
6		-	-	-	-	STW/ZSW	SOLL/IST	PZD 3	PZD 4	-	-	-	-	-	-	
7		PKE	IND	PKW 1	PKW 2	STW/ZSW	SOLL/IST	PZD 3	PZD 4	-	-	-	-	-	-	
8		-	-	-	-	STW/ZSW	SOLL/IST	PZD 3	PZD 4	PZD 5	PZD 6	PZD 7	PZD 8	-	-	
9		PKE	IND	PKW 1	PKW 2	STW/ZSW	SOLL/IST	PZD 3	PZD 4	PZD 5	PZD 6	PZD 7	PZD 8	-	-	
10		-	-	-	-	STW/ZSW	SOLL/IST	PZD 3	PZD 4	PZD 5	PZD 6	PZD 7	PZD 8	PZD 9	PZD 10	

(*) PPO3 is the standard telegram 1

In the drive parameter list there are two signal tables containing all the process data that can be cyclically read and written for the PROFIBUS communication DPV0. All possible writeable process data signals can be found in signal table 1284 (COM_DP_SignalList_Write) and all possible readable process data signals can be found in signal table 1285 (COM_DP_SignalList_Read). The most important readable and writeable parameters are also documented in chapter 8.

The writeable process data signals can be configured in signal table 915 (COM_DP_PZDSelectionWrite). The available number of writeable process data items is determined by the selected PPO type.

The readable process data signals can be configured in signal table 916 (COM_DP_PZDSelectionRead). The available number of readable process data items is likewise determined by the selected PPO type.

When using standard telegrams, the process data signals in the signal tables are automatically configured by the firmware.

NOTE

The content of this column applies only to PROFIBUS

A maximum of 15 process data signals can be mapped. Both single and double words can be used. The user-specific drive telegram types are described by a configuration identifier (ID) in the GSD file. This describes the structure of the cyclic user data based on a special identifier format shown in the diagram below.

Illustration 24.1 Identifier format

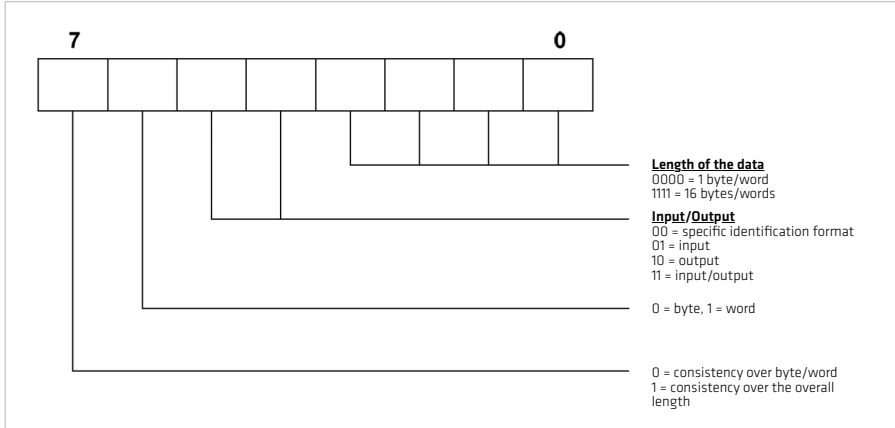

After the parameterisation phase, the master sends the drive a configuration telegram containing this special identifier (ID). On receipt of this, the drive compares the data in the configuration telegram with the configuration held in the drive. The identifier determined by the PPO type can be found in the GSD file under the heading „Modules“. The following table shows these identifiers for the user-specific telegrams.

Table 25.1 Listing of identifiers

No.	PPO type	PROFIBUS identifier (ID)	PROFINET module ID	PROFINET IRT module ID	Evaluation by special identifier format (table 27.2)	Referred to Table AK Slave-Master
1	1	0xF3 0xF1	0x65	0x165	4 words input/output data (consistent overall length) 2 words input/output data (consistent overall length)	PKW - channel PZD - channel
2	2	0xF3 0xF5	0x66	0x166	4 words input/output data (consistent overall length) 6 words input/output data (consistent overall length)	PKW - channel PZD - channel
3	3	0xF1	0x67	0x167	2 words input/output data (consistent overall length)	PZD - channel
4	4	0xF5	0x68	0x168	6 words input/output data (consistent overall length)	PZD - channel
5	5	0xF3 0xF9	0x69	0x169	4 words input/output data (consistent overall length) 10 words input/output data (consistent overall length)	PKW - channel PZD - channel
6		0xF3	0x6A	0x16A	4 words input/output data (consistent overall length)	PZD - channel
7		0xF3 0xF3	0x6B	0x16B	4 words input/output data (consistent overall length) 4 words input/output data (consistent overall length)	PKW - channel PZD - channel
8		0xF7	0x6C	0x16C	8 words input/output data (consistent overall length)	PZD - channel
9		0xF3 0xF7	0x6D	0x16D	4 words input/output data (consistent overall length) 8 words input/output data (consistent overall length)	PKW - channel PZD - channel
10		0xF9	0x6E	0x16E	10 words input/output data (consistent overall length)	PZD - channel
11		0xC0 0xCD 0xCD	0x6F	0x16F	14 words input/output data (consistent overall length)	PZD - channel
12		0xF3 0xC0 0xCD 0xCD	0x70	0x170	4 words input/output data (consistent overall length) 14 words input/output data (consistent overall length)	PKW - channel PZD - channel
13		0xC0 0xD1 0xD1	0x71	0x171	18 words input/output data (consistent overall length)	PZD - channel
14		0xF3 0xC0 0xD1 0xD1	0x72	0x172	4 words input/output data (consistent overall length) 18 words input/output data (consistent overall length)	PKW - channel PZD - channel
15		0xC0 0xD5 0xD5	0x73	0x173	22 words input/output data (consistent overall length)	PZD - channel

Table 26.1 Listing of identifiers

No.	PPO type	PROFIBUS identifier (ID)	PROFINET module ID	PROFINET IRT module ID	Evaluation by special identifier format (table 27.2)	Referred to Table AK Slave-Master
16		0xC0 0xD9 0xD9	0x75	0x175	26 words input/output data (consistent overall length)	PZD - channel
17		0xF3 0xC0 0xD9 0xD9	0x76	0x176	4 words input/output data (consistent overall length) 26 words input/output data (consistent overall length)	PKW - channel PZD - channel
18		0xF3 0xC0 0xDD 0xDD	0x78	0x178	4 words input/output data (consistent overall length) 32 words input/output data (consistent overall length)	PKW - channel PZD - channel
19		0xC0 0xDD 0xDD	0x77	0x177	32 words input/output data (consistent overall length)	PZD - channel

5.1.3 Parameter channel PKW

Some PPOs offer an additional cyclic parameter channel. This channel allows drive parameters to be read and written.

Table 271 Parameter channel PKW

PKW							
1. Byte	2. Byte	3. Byte	4. Byte	5. Byte	6. Byte	7. Byte	8. Byte
PKE (1 word)		IND (1 word)		PKW1 (1 word)		PKW 2 (1 word)	

The parameter consists of a total of four words: the parameter identifier PKE (1 word), the subindex IND (1 word) (sub-index 0 in the parameter must be addressed with 1) and the parameter identifier value, which occupies the data range PKW1 (1 word) to PKW2 (1 word). The parameter identifier is represented bit-by-bit in the following table.

Table 272 Parameter identifier PKE

AK				PNU											
15	14	13	12	11	10	9	8	7	6	5	4	3	2	1	0
AK				Request or response identifier (value range 0..15)											
PNU				Parameter number (value range 1...4095)											

The following tables list the request (master) and response (slave) identifiers.

Table 273 Request identifier AK (Master ↔ Slave)

Request identifier	Function
0	No request
1	Request parameter value
2	Change parameter value (word)
3	Change parameter value (double word)
4	Read parameter description
5	-
6	Request parameter value (array)
7	Change parameter value (array) (word)
8	Change parameter value (array) (double word)

Table 28.1 Response identifier AK (Slave ⇌ Master)

Response identifier	Function
0	No response
1	Parameter value sent (word)
2	Parameter value sent (double word)
3	Parameter description sent
4	Parameter value (array) sent (word)
5	Parameter value (array) sent (double word)
6	-
7	Request not executable, see error no.

In the case of response identifier 7 the error number sent to the drive from the master is shown in the range PKW1 to PKW2. The following table explains these error numbers.

Table 28.2 Response identifier AK (Slave ⇌ Master)

Error	Statement
0	Impermissible PNU
1	Parameter cannot be changed
2	Lower or upper parameter value limit transgressed
3	Defective sub-index
4	Not an array
5	Incorrect data type
...	
17	Request cannot be executed because of the operating status
18	Other error

Request identifier 4 can additionally be used to read a parameter description. The parameter description contains relevant information on the parameter concerned. The following table shows the subindices that can be used to access the individual parameter structure elements. The subindex is preset only by byte 3.

Table 29.1 Parameter description

Sub-index	Meaning	Data type
1	Identifier (ID)	V2
2	Number of field elements or string length	Unsigned 16
3	Standardisation factor	Floating Point
4	Variable attributes	OctetString 2
5	Reserved	OctetString 4
6	Name (only the first four bytes are sent)	VisibleString 16
7	Lower limit value	OctetString 4
8	Upper limit value	OctetString 4
9	Reserved	OctetString 2
10	ID extension	extension V2
11	PZD reference parameter	Unsigned 16
12	PZD standardisation	V2

The identifier (subindex 1) in the parameter description identifies additional characteristics of the parameter concerned. Table 27.2 sets out the meaning of the identifier.

Table 29.2 Identifier syntax

Bit	Meaning	Explanation
15	Reserved	
14	Array	
13	Parameter value can only be reset	If this bit is set, the relevant parameter value can be varied externally only so as to be set to zero.
12	Parameter value was changed to a value different from the factory settings	If this bit is set, the parameter value is different from the factory setting.
11	Reserved	
10	Additional text array can be called up	
9	Parameter cannot be written	
8	Standardisation factor and variable attributes not relevant	This bit is set if the parameter is of a data type that cannot be used to calculate any physical values (e. g. data type string)
0 - 7	Data type of the parameter value (value = „Profi-Drive table 9“)	

5.2 Monitoring

The YukonDrive® provides two options for monitoring cyclic communication.

5.2.1 Watchdog

Parameter 1283 (COM_DP_BUS_Timeout) can be used to configure a watchdog.

Table 30.1 Watchdog

Parameter no.	Name	Meaning	Data type	Unit
P1283	COM_DP_BUS_Timeout	Watchdog for cyclic communication	INT32 (0 - 4294967295)	ms

The watchdog is activated after the first cyclic telegram, and in the event of an error triggers error (32-1) if no cyclic telegrams are received in the time defined by parameter 1283 (COM_DP_BUS_Timeout).

The value 0 in parameter 1283 (COM_DP_BUS_Timeout) deactivates the function.

5.2.2 Sign of Life

The Sign of Life function is implemented as per Profidrive profile 4.1.

Table 30.2 Sign of life

Parameter no.	Name	Meaning
P0925	COM_PN_Sign_of_life_limit	Number of approved SOL (Sign of Life) errors until error shutdown type U16: 0 - 0xffff, 0xffff = switch off
P1296	COM_PN_Sign_of_life_err_cnt	Display of current error counter
P1280	Control word 2	Bit 12-15 Sign of Life master
P1281	Control word 2	Bit 12-15 Sign of Life slave

The Sign of Life function can be deactivated with the value 0xFFFF in parameter 925 (COM_PN_Sign_of_life_limit) (factory setting).

The function is activated when the first cyclic telegram is received in which bits 12-15 of the second control word (1280) are not equal to 0. When the function is activated, the error counter parameter 1296 (COM_PN_Sign_of_life_err_cnt) is set to 0.

With each newly received telegram the counter (bits 12-15) in the second status word parameter 1281 (COM_DP_Statusword2) is incremented by the value 1.

In each cycle the status counter is compared with the counter in the second control word. If that counter is not equal, the error counter parameter 1296 COM_PN_Sign_of_life_err_cnt) is incremented by the value 10. If the counters in the second control word and second status value are equal, the error counter parameter 1296 COM_PN_Sign_of_life_err_cnt) is decremented by the value 1. The error counter cannot fall below 0.

If the error counter parameter 1296 (COM_PN_Sign_of_life_err_cnt) is greater than or equal to 10 * parameter 925 (COM_PN_Sign_of_life_limit) the error message (32-03 Profinet IRT: Sign of Life error) is triggered and bit 4 in parameter 953 (COM_DP_Warning) is set.

If cyclic transfer is interrupted and then re-established, the error counter parameter 1296 COM_PN_Sign_of_life_err_cnt) is cleared and the warning bit 4 in parameter 953 (COM_DP_Warning) is reset.

Normal operation Sign of Life

Illustration 31.1 Normal operation Sign of Life

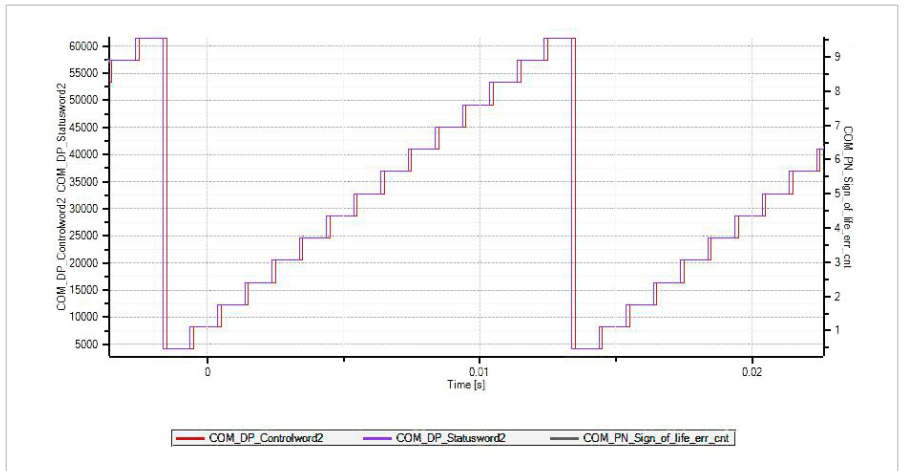

Sign of Life errors triggered

Illustration 32.1 Sign of Life errors triggered

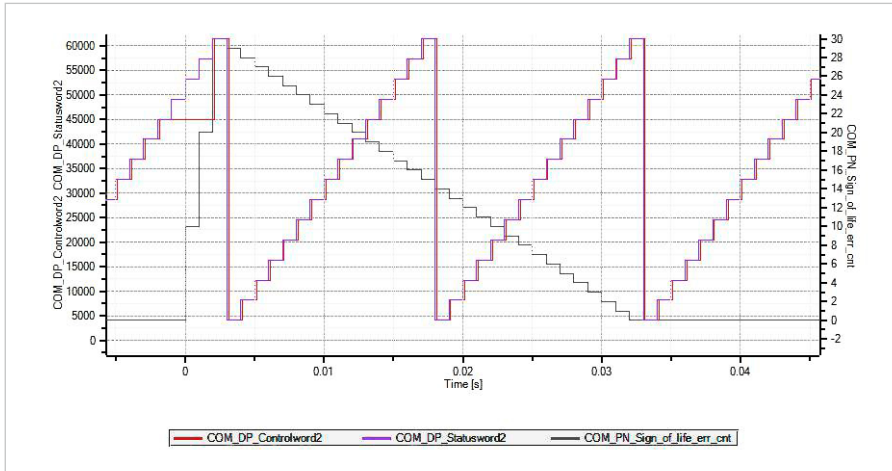

The value of the master is not increased in three cycles. The error counter is increased by the value 10 in each of these cycles. When the master generates the Sign of Life again, the error counter is decreased by the value 1 in each cycle.

4 Sign of Life errors triggered with error reaction

Illustration 33.1 4 Sign of Life errors triggered with error reaction

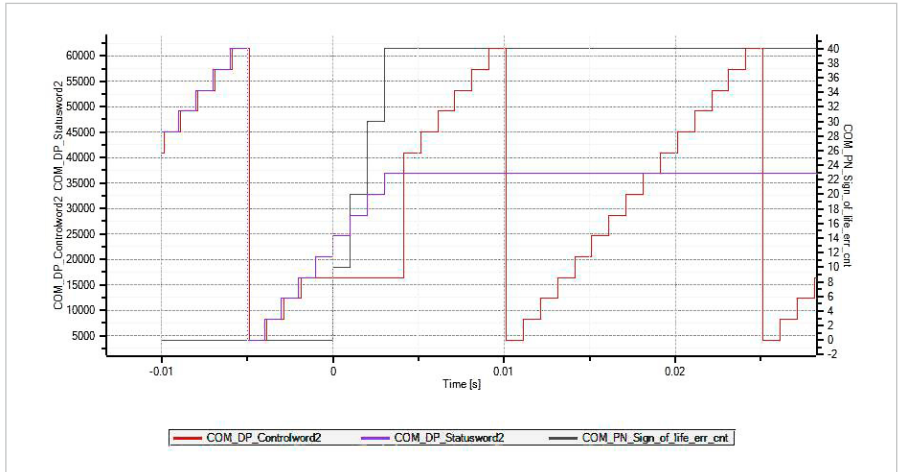

The value of the master is not increased in four cycles if a value 4 is entered in parameter 925 (COM_PN_Sign_of_life_limit). The error counter is increased by the value 10 in these cycles. When the error counter reaches the maximum value (40), the error reaction is triggered.

6. Acyclic data transfer

The PROFIdrive profile includes the „Base Mode Parameter Access“ model for this. It is used for both PROFIBUS and PROFINET.

6.1 PROFIBUS parameter access

In addition to cyclic data communication, which is intended as the default for quick updating of I/O process data, acyclic services are offered for one-off events. They offer the facility to read or write parameters acyclically, for example, so as not to impede cyclic data traffic. Telegram type SD2 as set out in the following table is used for the PROFIBUS DP extension DPV1.

Table 34.1 PROFIBUS SD2 telegram for DPV1 services

SD	LE	LEr	SD	DA	SA	DSAP	SSAP	DU	FCS	ED
Start Delimiter	Length	Length repeat	Start Delimiter	Destination Address	Source Address	Destination Service Access Point	Source Service Access Point	Data Unit	Frame Check Sequence	End Delimiter
68H	X	X	68H	xx	xx	xx	xx	X..		

The acyclic services can be used by a class 1 master (PLC etc.) and by a class 2 master (PC tool). The following table gives an overview of the acyclic services available in relation to the respective master class.

Table 34.2 Overview of acyclic services offered

Acyclic services	Master class	Meaning	DSAP	SSAP
Initiate request	2	Establish an acyclic connection	32H	31H
Abort request	2	Break off an acyclic connection	32H	0..30H
Read request	2	Read request via DPV1	32H	0..30H
Write request	2	Write request via DPV1	32H	0..30H
Data request	2	Data transfer	32H	0..30H
Read request	1	Read request via DPV1	33	33H
Write request	1	Write request via DPV1	33	33H
Alarm	1	Interrupt handling	33	33H

DPV1 is always accessed according to a fixed mechanism:

Table 35.1

1. Write request (5F)										
SD	..	DSAP	SSAP	DU Req. id	DU Slot	DU Index	DU Length	DU User	FCS	ED
68H	xx	32	30	5F	0	2F	n+1	0..n	xx	16H

Table 35.2

2. Write response (5F)										
SD	..	DSAP	SSAP	DU Req. id	DU Slot	DU Index	DU Length	FCS	ED	
68H	xx	32	30	5F	0	2F	n+1	xx	16H	

Table 35.3

3. Read request (5E)										
SD	..	DSAP	SSAP	DU Req. id	DU Slot	DU Index	DU Length	FCS	ED	
68H	xx	32	30	5E	0	2F	MAX	xx	16H	

Table 35.4

4. Read response (5E)										
SD	..	DSAP	SSAP	DU Req. id	DU Slot	DU Index	DU Length	DU User	FCS	ED
68H	xx	32	30	5E	0	2F	n+1	0..n	Xx	16H

Each read or write access must first be initiated by a write service on Data Unit Index 47 ($2F_{Hex}$) (1). This write request gives the slave the information about the request to execute. After this the slave acknowledges with a response telegram (2), which initially contains no response data.

This is simply an acknowledgement of the request and contains only the mirrored DPV1 header of the request telegram. In the event of an error, a negative response is sent. To then read the data from the slave, the master must present a read request (3). If the response (4) to this is positive, the user data can be used by the master. In the event of an error, a negative response is sent. The „DPV1 read request“ diagram shows the telegram sequence for read access. This shows the slave sending a negative read response to the first read request. This negative read response means that the required data cannot yet be provided.

Not until the following cycle, the slave has executed the request to the extent that it can send a positive read response with the requested data.

Illustration 36.1 DPV1 read request

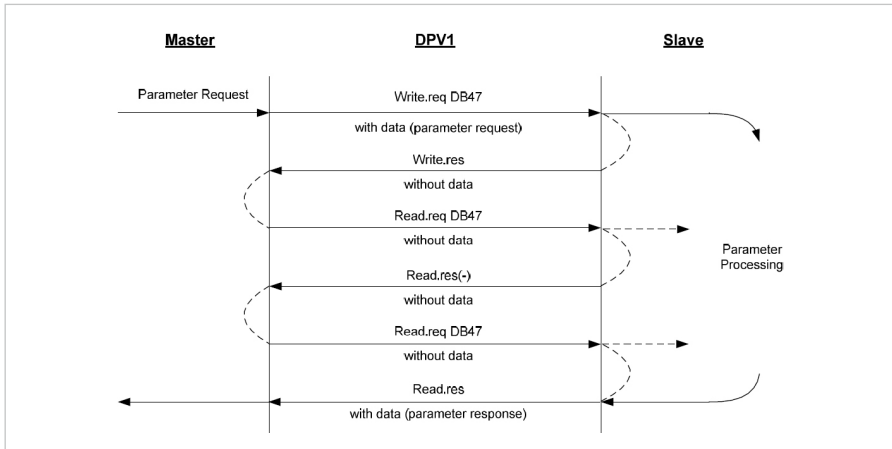

This transfer format is „Big Endian“ (Motorola, the highest byte is transmitted first).

Table 36.2

Word format:	
0. Byte	1. Byte
High Byte	Low Byte

Table 36.3

Double word format			
0. Byte	1. Byte	2. Byte	3. Byte
High Byte	Low Byte	High Byte	Low Byte
High Word	High Word	Low Word	Low Word

The data unit in the table „PROFIBUS SD2 telegram for DPV1 services“ of telegram type SD2 can be split into five areas:

- Req.id (1 byte)
This is the function number of the DPV1 service. This describes, for example, whether a parameter is to be read or written. More detailed information can be found in the table headed „Data unit assignment“.
- Slot (1 byte)
DPV1 slaves consist of a number of physical or virtual slots.
The drive is triggered by addressing a slot, following which the slot address is not evaluated.
- Index (1 byte)
The index contains the address of the data area in which the slave makes available the data for parameter access. In accordance with ProfiDrive this is specified with the fixed data area number 47.
- Length (1 byte)
Indicates the length of the user data that follow. In the case of a read access, the length must be sufficiently large for the data to be read (max. 240 bytes).
- UserData (1 byte...n bytes)
Contains the user data to be processed.

Table 371 Data unit assignment

Data Unit (DU) Byte	Data Unit Param	Value	Value	
0	Req.id	48H	Idle REQ, RES	Idle REQ, RES
		51H	Data Transport REQ, RES	Data transport REQ,
		56H	Resource Manager, REQ	Resource manager REQ
		57H	Initiate REQ, RES	Initiate REQ, RES
		58H	Abort REQ	Abort REQ
		5CH	Alarm REQ, RES	Alarm REQ, RES
		5EH	Read REQ, RES	Read REQ, RES
		5FH	Write REQ, RES	Write REQ, RES
		D1H	Data Transport NEG RES	Data transport negative RES
		D7H	Initiate NEG RES	Initiate negative RES
		DCH	Alarm NEG RES	Alarm negative RES
		DEH	Read NEG RES	Read negative RES
		DFH	Write NEG RES	Write negative RES
		1	Slot	00H..FEH
2	Index	2FH	Index	
3	Length	xx	Length of user data (max. 240 bytes)	
4..n	UserData	xx	User data	
[Alarms are not currently supported]				

6.1.1 PROFINET parameter access

In the case of PROFINET the acyclic services are executed by way of the „Record Data CR (connection relationship)“. There are read and write commands for the purpose.

Table 38.1 Master control word 2

Master	Slave
Parameter request „Write Data Record“ with index 0xB02E	Read response OK or error message (0xDF)
Parameter request „Read Data Record“ with index 0xB02E	Write response OK or error message (0xDE)

6.1.2 „Base Mode Parameter Access“ data format

The following table shows the telegram format of parameter access for a parameter request and response.

Table 38.2 Data unit assignment

Base mode parameter request			Byte address
Request header	Request reference	Request identification	0
	Axis no.	No. of Parameters (n)	2
1st parameter address	Attribute	No. of elements	3
	Parameter Number (PNU)		
	Subindex		
nth parameter address		$4+6*(n-1)$
	Format	No. of values	$4+6*n$
	Values		
	...		
		
			$4+6*n+...+$ (format_n *amount_n)

Table 38.3 Parameter response

Base mode parameter response			Byte address
Response header	Request reference (mirror)	Response identification	0
	Axis no. (mirror)	No. of Parameters (n)	2
1st parameter value	Format	No. of values	4
	Value / error code		
	...		
nth parameter value		
			$4+...+$ (format_n *amount_n)

The user data are structured as follows:

- **Request reference:**
The request reference is specified by the master and mirrored back by the slave in the response telegram. Based on this reference the master can uniquely assign each response telegram to a request telegram. A master changes the request reference with each new request.
- **Request ID**
This identifier essentially describes how the parameter is handled. Currently two different identifiers are defined:
 - Request parameter
 - Change parameterFor more details on the identifier refer to the „User data“ table.
- **Response ID**
This identifier contains information on the origin of a request. If a request is executed correctly, the response ID matches the request ID. If a request cannot be executed, an identifier from the „User data“ table is generated.
- **Axis no.**
This value allows single axes in a multi-axis system to be addressed selectively (Axis no. ⇔ 0 = single axis).
- **No. of Parameters**
Number of parameters processed in a request.
- **Attribute**
Describes the individual access to a parameter structure. For example, whether access to the actual numerical value or to the parameter description text is desired. Further information can be found in the „User data“ table.
- **Number of Elements**
When accessing an array or a string, this area contains the field size or string length as appropriate.
- **Parameter Number**
Contains the parameter number (PNU).
- **Subindex**
Addresses the first array element of a parameter or the beginning of a character string. This also allows addressing of description texts and text arrays.
- **Format**
Specifies the relevant parameter and ensures unique assignment of the parameter value in the telegram.
- **Number of values**
Number of following values
- **Values**
Parameter values

Table 40.1 User data

Field name	Data type	Value	Meaning	Comments
Request reference	Unsigned8	0x00 0x01..0xFF	Reserved	
Request ID	Unsigned8	0x00 0x01 0x02 0x03..0x03F 0x40..0x7F 0x80..0xFF	Reserved Request parameter Change Parameter Reserved Manufacturer-specific Reserved	
Response ID	Unsigned8	0x00 0x01 0x02 0x03..0x3F 0x40..0x7F 0x80 0x81 0x82 0x83..0xBF 0xC0..0xFF	Reserved Request parameter (+) Change Parameter (+) Reserved Manufacturer-specific Reserved Request parameter (-) Change Parameter (-) Reserved Manufacturer-specific	
Axis no.	Unsigned8	0x00 0x01..0xFE 0xFF	Device Representative Axis-Number 1..254 Reserved	Zero = single axis
No. of Parameters	Unsigned8	0x00 0x01..0x27 0x28..0xFF	Reserved Quantity 1..39 Reserved	Limited by DPV1 Telegram length
Attribute	Unsigned8	0x00 0x10 0x20 0x30 0x40..0x70 0x80..0xF0	Reserved Value Description Text Reserved Manufacturer-specific	
No. of Elements	Unsigned8	0x00 0x01..0xEA 0xEB..0xFF	Special Function Quantity 1..234 Reserved	Limited by DPV1 Telegram length
Parameter Number	Unsigned16	0x0000 0x0001... 0xFFFF	Reserved Number 1..65535	
Subindex	Unsigned16	0x0000... 0xFFFF	Number 1..65535	
Format	Unsigned8	0x00 0x01..0x36 0x37..0x3F 0x40 0x41 0x42 0x43 0x44 0x45..0xFF	Reserved Data Types Reserved Zero Byte Word Double Word Error Reserved	
No. of Values	Unsigned8	0x00..0xEA 0xEB..0xFF	Quantity 0..234 Reserved	Limited by DPV1 Telegram length
Error Number	Unsigned16	0x0000... 0x00FF	Error Numbers (see table below)	

Table 41.1 Error numbers

Error number	Meaning
0x00	Impermissible parameter number
0x01	Parameter value cannot be changed
0x02	Value area of the parameter transgressed
0x03	Defective parameter sub-index
0x04	Parameter is not an array
0x05	Incorrect parameter data type
0x06	Change access with value not equal to zero, which is not permitted
0x07	Change access on a descriptive element, which cannot be changed
0x09	No descriptive text available
0x11	Request cannot be performed in the present system status
0x14	Impermissible value
0x15	Reply telegram is too long
0x16	Impermissible parameter address
0x17	Illegal format
0x18	Number of parameter values is inconsistent
0x19	Request for a non-existent axis

6.2 Examples of request and response telegrams

Table 42.1 ID:2 Change Parameter, Attr. 0x10: Value; Pnu = 918 = 0x396, Format word=0x42

Write word													
Refer.	Req. ID	Axis	No. Param.	Attr.	No. Ele.	Pnu high	Pnu Low	Sub high	Sub low	Format	No. Values	Value high	Value Low
0	2	0	1	0x10	0..1	3	0x96	0	0	0x42	1	0	7

Table 42.2 ID:2 Change Parameter

Positive response			
Refer.	Req. ID	Axis	No. Param.
0	2	0	1

Parameter 918 now has the value 7

Table 42.3 ID:2 Change Parameter, Attr. 0x10: Value; Pnu = 1274 = 0x4FA, Format word=0x43

Write double word							
Refer.	Req. ID	Axis	No. Param.	Attr.	No. Ele.	Pnu high	Pnu Low
0	2	0	1	0x10	0..1	4	0xFA
Sub high	Sub low	Format	No. Values	Value high	Value Low	Value I high	Value I low
0	0	0x43	1	1	2	3	4

Table 42.4 ID:2 Change Parameter

Refer.	Req. ID	Axis	No. Param.
0	2	0	1

Parameter 884 now has the value 16909060

Read simple parameter value

Table 42.5 ID:1 Request Parameter, Attr. 0x10: Value; Pnu = 922 = 0x39A

Read word									
Refer.	Req. ID	Axis	No. Param.	Attr.	No. Ele.	Pnu high	Pnu Low	Sub high	Sub low
0	1	0	1	0x10	0..1	3	0x9A	0	0

Read simple parameter value

Table 43.1 Format word=0x42; Parameter value = 9

Positive response							
Refer.	Req. ID	Axis	No. Param.	Format	No. values	Value high	Value low
0	1	0	1	0x42	1	0	9

Table 43.2 ID:1 Request Parameter, Attr. 0x10: Value; Pnu = 1274 = 0x4FA

Read double word									
Refer.	Req. ID	Axis	No. Param.	Attr.	No. Ele.	Pnu high	Pnu Low	Sub high	Sub low
0	1	0	1	0x10	0..1	4	0xFA	0	0

Table 43.3 Format dword=0x43; Parameter value = 0x01020304 = 16909060

Positive response									
Refer.	Req. ID	Axis	No. Param.	Format	No values	Value H high	Value H Low	Value I high	Value I low
0	1	0	1	0x43	1	1	2	3	4

Error access

Table 43.4 ID:1 Request Parameter, Attr. 0x10: Value; Pnu = 9

Erroneous parameter number									
Refer.	Req. ID	Axis	No. Param.	Attr.	No. Ele.	Pnu high	Pnu Low	Sub high	Sub low
0	1	0	1	0x10	0..1	0	9	0	0

Negative response

Table 43.5 Format error=0x44; parameter value = 0 = incorrect parameter number

Refer.	Req. ID	Axis	No. Param.	Format	No. values	Value high	Value low
0	0x81	0	1	0x44	1	0	0

Write parameter values array

Table 44.1 ID:2 Change Parameter, Attr. 0x10: value: PNU = 918 = 0x396, format word=0x42

Refer.	Req. ID	Axis	No. Param.	Attr.	No. Ele.	Pnu high	Pnu Low	Sub high	Sub low
0	2	0	1	0x10	5	3	0x93	0	0
Format	No. Values	Value 0 high	Value 0 Low	-	Value 4 high	Value 4 low			
0x42	5	3	C7		0	0			

Parameter values = 0x03C7, 0x04F6, 0x04F6, 0x04F6, 0

OK response

Refer.	Req. ID	Axis	No. Param.
0	2	0	1

Parameter 915 now contains the entries for the parameter values.

No standard telegram smaller than 10 may set up in the device, because then it could not be overwritten; as a remedy set PPO5.

Read parameter values array

Table 44.2 ID:1 Attr. : 0x10 Pnu = 915=0x393

Read assigned process data reference values									
Refer.	Req. ID	Axis	No. Param.	Attr.	No. Ele.	Value 0 high	Value 0 Low	Value 4 high	Value 4 low
0	2	0	1	0x10	5	3	C7	0	0

OK Antwort

Table 44.3 ID:1 Format: 0x42

Refer.	Req. ID	Axis	No. Param.	Format	No. Values	Value 0 high	Value 0 low	Value 1 high	Value 1 Low
0	1	0	1	0x42	5	3	0xC7	4	0xF6
Value 2 high	Value 2 Low	Value 3 high	Value 3 Low	Value 4 high	Value 4 low				
4	0xF6	5	0	0	0				

[7. Profidrive operation modes](#)

[7.1 Operation modes](#)

The YukonDrive® support the following operation modes

- Speed control jog mode
- Position control jog mode
- Speed control (application class 1)
- Position control (application class 3)
- Position control (interpolating mode)

Operation modes are selected by standard telegram selection in the master or by using free telegrams and configuring the following parameters:

Table 45.1 Watchdog

Parameter no.	Name	Meaning
P-0300	CON_CfgCon	Set control mode
P-0301	CON_REF_Mode	Set reference profiles

7.1.1 Speed control circuit and associated control parameters

Illustration 46.1 Speed control loop

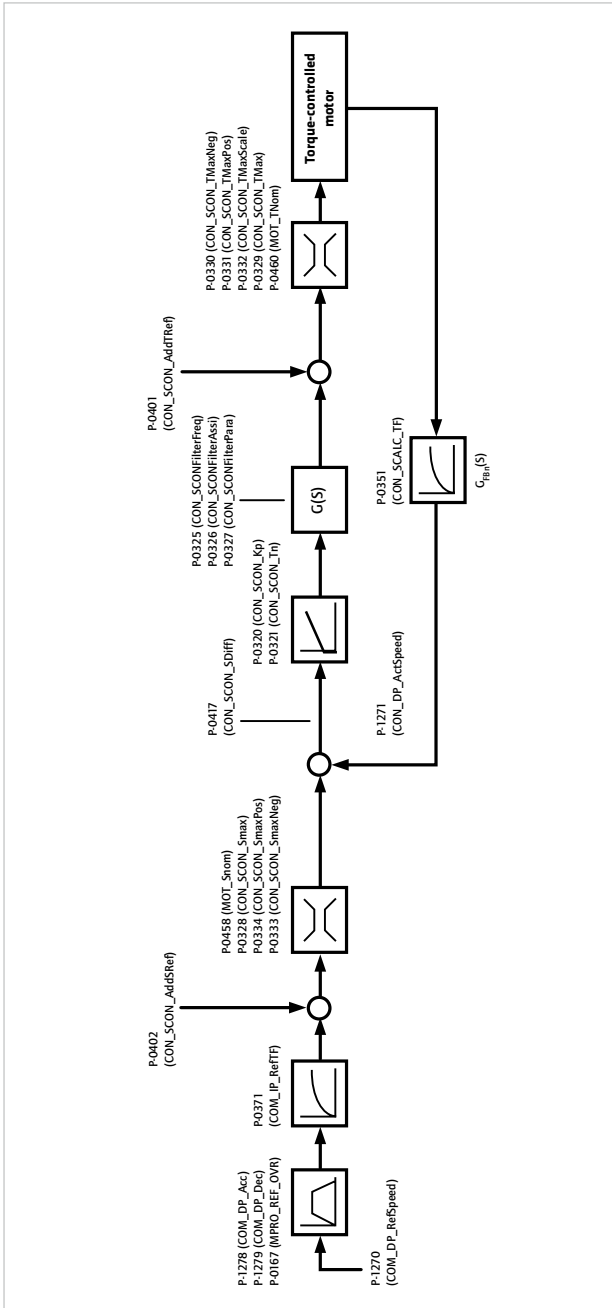

Table 471 Control parameters

Parameter no.	Parameter name	Meaning
P-0167	MPRO_REF_DVR	Velocity override
P-0320	CON_SCON_Kp	PI speed controller gain
P-0321	CON_SCON_Tn	PI speed controller integral-action time
P-0325	CON_SCONFilterFreq	Limit frequencies for torque reference value filter
P-0326	CON_SCONFilterAssi	Torque reference value filter draft parameter
P-0327	CON_SCONFilterPara	Torque reference filter parameter
P-0328	CON_SCON_SMax	Speed limit (reference variable: motor nominal speed)
P-0330	CON_SCON_TMaxNeg	Negative torque limit (reference variable: nominal torque)
P-0331	CON_SCON_TMaxPos	Positive torque limit (reference variable: nominal torque)
P-0332	CON_SCON_TMaxScale	Torque scaling factor
P-0333	CON_SCON_SMaxNeg	Negative speed limitation (reference value: motor nominal speed)
P-0334	CON_SCON_SMaxPos	Positive speed limitation (reference value: motor nominal speed)
P-0339	CON_SCON_Tmax	Torque limitation (reference value: nominal torque)
P-0351	CON_SCALC_TF	Actual speed filter time constant
P-0371	CON_IP_RefTF	Speed reference filter time constant
P-0401	CON_SCON_AddTRef	Additive torque reference
P-0402	CON_SCON_AddSRef	Additive velocity reference
P-0417	CON_SCON_SDiff	Speed controller differential
P-0458	MOT_Snom	Motor nominal speed
P-0460	MOT_TNom	Motor nominal torque
P-1270	COM_DP_RefSpeed	Velocity reference
P-1271	COM_DP_ActSpeed	Actual speed
P-1278	COM_DP_Acc	Acceleration ramp
P-1279	COM_DP_Dec	Deceleration ramp

7.2 Drive state machine

Illustration 48.1 General system state machine (control via PROFIBUS and PROFINET)

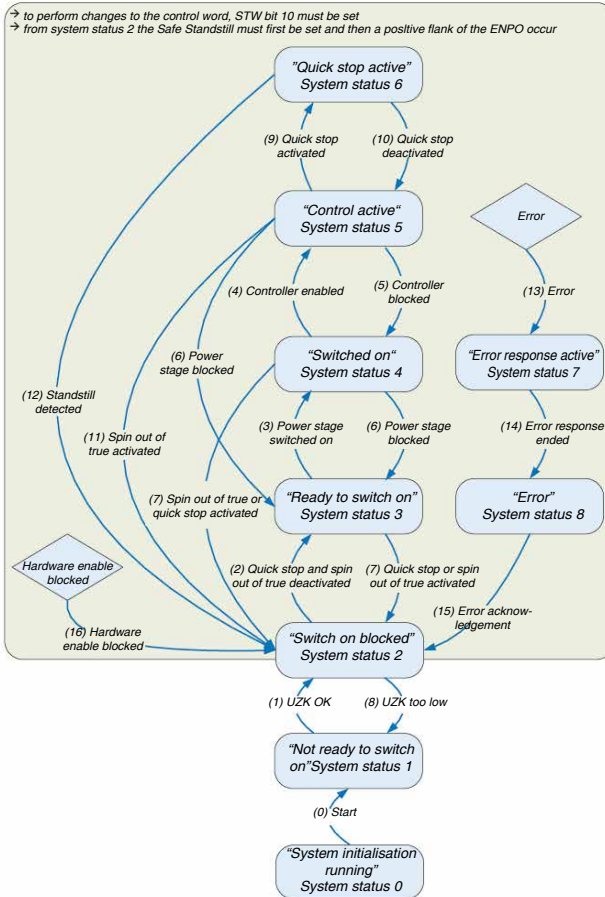

Table 49.1 System states

System state	Designation	Description
0	System initialisation in progress (start)	Initialisation after device reset (e. g. hardware, parameter list, controller, ...)
1	Not ready to switch on	Initialisation completed, but no power supply, or intermediate circuit voltage less than switch-on threshold
2	Switch on disabled	DC-link voltage greater than switch-on threshold
3	Ready to switch on	Optional conditions satisfied (e.g. homing run, quick stop inactive ...)
4	Switched on	Power stage enabled
5	Operation enabled	Power supplied to motor, operation active
6	Quick stop active	Quick stop active *
7	Error reaction active	Error reaction is active, reference values from the PROFIBUS master are ignored.
8	Error	Drive in error state, reference values from the PROFIBUS master are ignored

* Quick stop can be triggered by various circumstances. The parameter 2218 (MP_QuickStopOC) allows the type of quick stop to be selected.

Table 49.2 Quick stop option codes

Quick stop option code	Meaning
0	Disable drive function
1	Slow down on slow down ramp
2	Slow down on quick stop ramp
3	Slow down on the current limit
4	Slow down on the voltage limit
5	Slow down on slow down ramp and stay in „quick stop“
6	Slow down on quick stop ramp and stay in „quick stop“
7	Slow down on the current limit and stay in „quick stop“
8	Slow down on the voltage limit and stay in „quick stop“

Table 50.1 System state transitions

System state transition	Designation	Description
0	Start	Initialisation after boot-up complete
1	UZK OK	DC-link voltage greater than switch-on threshold
2	Quick stop and Coast down deactivated	Coast down deactivated ⇨ STW Bit 1 = 1 Quick stop deactivated ⇨ STW Bit 2 = 1
3	Power stage switched on	Switch power stage on ⇨ STW Bit 0 = 1
4	Control enabled	Enable control ⇨ STW Bit 3 = 1
5	Control disabled	Disable control ⇨ STW Bit 3 = 0 *
6	Power stage blocked	Disable power stage ⇨ STW Bit 0 = 0
7	Quick stop or Coast down activated	Coast down activated ⇨ STW Bit 1 = 0 Quick stop activated ⇨ STW Bit 2 = 0
8	UZK too low	Intermediate circuit voltage less than switch-on threshold
9	Quick stop activated	Activate quick stop ⇨ STW Bit 2 = 0
10	Quick stop deactivated	Deactivate quick stop ⇨ STW Bit 2 = 1
11	Coast down activated	Activate Coast down ⇨ STW Bit 1 = 0
12	Standstill detected	Standstill was detected
13	Error	Error event occurred (can occur in any system state)
14	Error reaction ended	Error reaction ended (e. g. error stop ramp)
15	Error reset	Reset error ⇨ STW Bit 7 = 1 or by a rising edge of Enpo
16	Power stage blocked	Power stage blocked (can occur in any system status)

Parameter 144 (Autostart) determines whether control enable is flank-triggered (0) or status-dependent (1) [Parameter List ⇨ Motion Profile ⇨ Basic Settings].

[7.3 Jog mode](#)

[7.3.1 Jog mode manufacturer-specific](#)

Bits 8 and 9 of the control word permit jog mode in speed operation:

When bit 8 of parameter COM_DP_CtrlConfig is set to 0, the drive acts as follows (jog mode manufacturer-specific):

- When bit 8 is changed to 1, the drive adopts the speed in parameter 1268 COM_DP_RefJogSpeed1.
- If bit 9 is additionally set to 1, the value of parameter 1269 COM_DP_RefJogSpeed2 is used as the reference (setpoint).
- If bit 9 is set to 0 again, COM_DP_RefJogSpeed1 is again used as the reference.
- If bit 8 is set to 0 while bit 9 is still set to 1, no change occurs.
- When bit 9 is changed to 1, the drive adopts the negated speed in parameter COM_DP_RefJogSpeed1. The direction of rotation is reversed as a result.
- If bit 8 is additionally set to 1, the negated value of parameter COM_DP_RefJogSpeed2 is used as the reference (setpoint).
- If bit 8 is set to 0 again -COM_DP_RefJogSpeed1 is again used as the reference.
- If bit 9 is set to 0 while bit 8 is still set to 1, no change occurs.
- If negative references are set, a negated velocity becomes positive again.
- Jog mode can only be activated when the motor is stopped.

[7.3.2 Jog mode conforming to profile](#)

When bit 8 of parameter COM_DP_CtrlConfig is set to 1, the drive acts in conform to the profile (profile 4.1) - page 84 [13]:

- Jog mode can only be activated when the motor is stopped.
- Bits 4 to 6 of the control word are 0.
- When bit 8 is changed to 1, the drive adopts the velocity in parameter COM_DP_RefJogSpeed1.
- When bit 9 is changed to 1, the drive adopts the velocity in parameter COM_DP_RefJogSpeed2.
- When bits 8 and 9 are set there is no change; the old reference value is retained.

[7.3.3 Jog mode reference parameters](#)

- Parameters 1268 COM_DP_RefJogSpeed1 and 1296 COM_DP_RefJogSpeed2 are of type Int32 and mappable as process data.
- The acceleration and deceleration are used in jog mode by parameters 1278 COM_DP_ACC and 1279 COM_DP_D

7.4 Speed control (application class 1)

In speed control mode the speed control reference value can be influenced using 3 bits in the master control word (7.4.1).

Illustration 52.1 Speed control

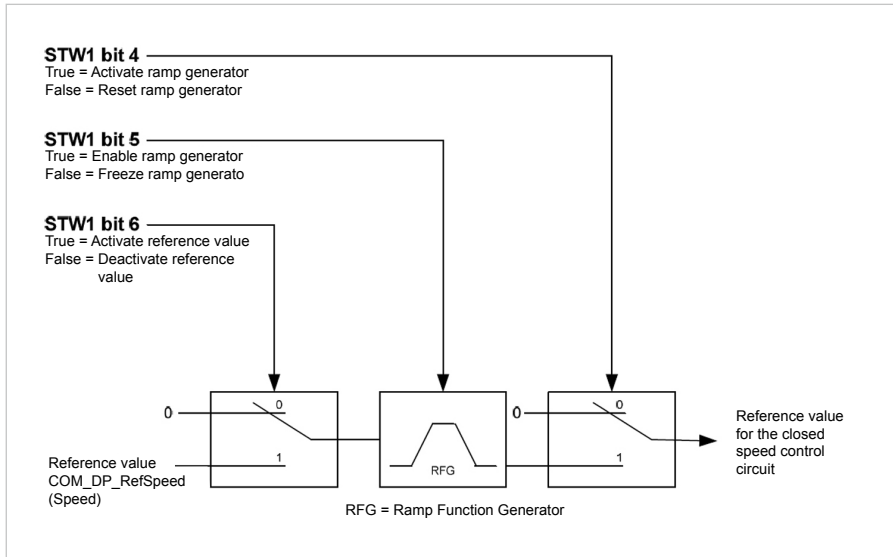

Setting the control word bit 4 allows the speed reference value to be taken over by the ramp generator. The ramp generator can be enabled by setting control word bit 5; resetting it freezes the ramp generator again. The input of the ramp generator is influenced by control word bit 6. If bit 6 is set, the reference value is switched through. If bit 6 is not set, the reference value zero is transmitted.

7.4.1 Master control word

Table 53.1 Master control word

Bit	Operation mode: Speed control	Operation mode: Position control
Bit 15 (MSB)		
0		Apply relative positioning immediately after start enable
1		Speed mode
Bit 14		
0		Normal positioning
1		Speed mode
Bit 13		
0	Not used	New reference values activated by toggling master control word bit 6
1	Not used	New reference values are applied directly. Special function: Feed hold is disabled.
Bit 12		
0	Not used	Positioning reference value = absolute
1	Not used	Positioning reference value = relative
Bit 11		
0	Not used	Stop homing
1	Not used	Start homing
Bit 10		
0	No access rights via PLC	
1	Access rights via PLC	
Bit 9		
0	Jog mode 2 off	Jog mode 2 off
1	Jog mode 2 on	Jog mode 2 on
Bit 8		
0	Jog mode 1 off	Jog mode 1 off
1	Jog mode 1 on	Jog mode 1 on
Bit 7		
0	Error reset on rising edge 0 ⇒ 1	
1		

Table 54.1 Master control word

Bit	Operation mode: Speed control	Operation mode: Position control
Bit 6		
0	Deactivate reference value	Activate driving set via rising and falling edge
1	Activate reference value	(0 ⇔ 1 and 1 ⇔ 0)
Bit 5		
0	Freeze ramp generator	No feed hold
1	Unfreeze ramp generator	Feed hold
Bit 4		
0	Reset ramp generator	Abort driving set
1	Activate ramp generator	Do not abort driving set
Bit 3		
0	Controller not enabled	
1	Controller enabled (operation enabled)	
Bit 2		
0	Quick stop active	
1	Quick stop inactive	
Bit 1		
0	Coast down active	
1	Coast down inactive	
Bit 0		
0	Switch power stage OFF	
1	Switch power stage ON	

Table 54.2 Master control word 2

Bit	Meaning
Bit 0 - 11	Not used
Bit 12 - 15	Master Sign of Life (SOL)

With parameter 1267 COM_DP_CtrlConfig bits 6 and 8 can be configured:

Table 54.3 Master control word

Bit	Value = 0 (default)	Value = 1
Bit 6	The driving job can be started with the negative and positive edge (profile 4.0).	The driving job can be started only with the positive edge (profile 4.1).
Bit 8	Jog mode is manufacturer-specific	Jog mode acts as described in profile 4.1.

7.4.2 Drive status word

Table 55.1 Drive status word

Bit	Operation mode: Speed control	Operation mode: Positioning control
Bit 15 (MSB)	Not used	
Bit 14		
0	„ENPO“ or „Safe Standstill“ not set	
1	„ENPO“ or „Safe Standstill“ set	
Bit 13		
0	Drive rotating	
1	Drive stationary	
Bit 12		
0	Not used	Driving job confirmation by toggling this bit
1	Not used	Driving job confirmation by toggling this bit
Bit 11		
0	Not used	Homing point not yet set
1	Not used	Homing point set
Bit 10		
0	Frequency or speed not reached	Target position not reached
1	Frequency or speed reached or exceeded	Target position reached
Bit 9		
0	No access rights via PLC	
1	Access via PLC allowed	
Bit 8		
0	Velocity error out of tolerance band	Positioning tracking error out of tolerance band
1	Velocity error within tolerance band	Positioning error within tolerance band
Bit 7		
0	No warning	
1	Warning issued	
Bit 6		
0	Switch on not prevented	
1	Switch on prevented	
Bit 5		
0	Quick stop activated	
1	Quick stop deactivated	

Table 56.1 Drive status word, continuation

Bit	Operation mode: Speed control	Operation mode: Positioning control
Bit 4		
0	Coast down activated	
1	Coast down deactivated	
Bit 3		
0	No error	
1	Error reported	
Bit 2		
0	Control disabled	
1	Control active (in operation / drive following reference values)	
Bit 1		
0	Power stage inactive (not ready)	
1	Power stage active (ready)	
Bit 0		
0	Not ready for start	
1	Ready for start	

Table 56.2 Drive status word 2

Bit	Meaning
0-1	Profile generator status 0: Stop 1: Acceleration 2: Positioning with sel. velocity 3: Deceleration
2	Torque limitation with positive direction of travel
3	Torque limitation with negative direction of travel
4	ISD00
5	ISD01
6	ISD02
7	ISD03
8	Reserved
9	Reserved
10	Reserved
11	Reserved
12-15	Slave Sign of Life (SOL)

7.5 Position control (application class 3)

In position control mode, from operating state 5 the drive can switch to various states in response to defined bits in the master control word. These states are illustrated in the diagram 571.

Illustration 571 Position control

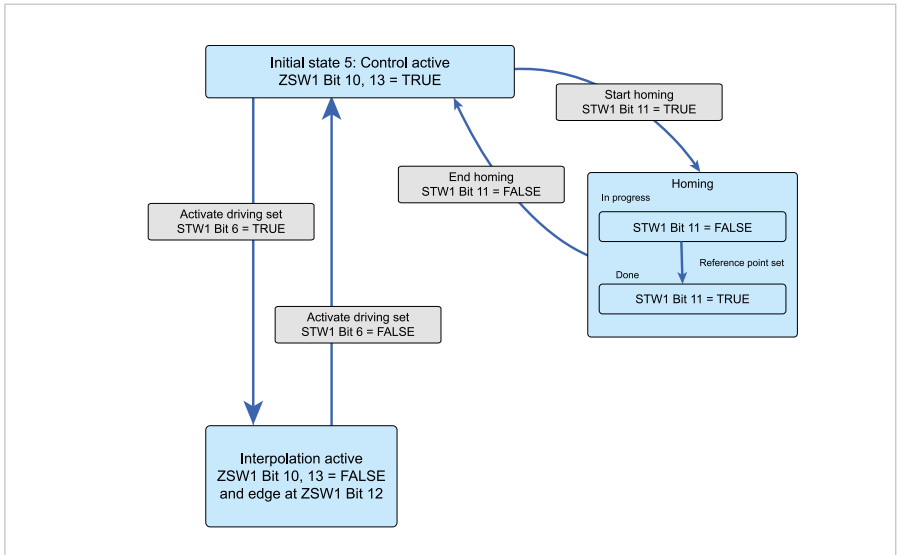

A positioning command is activated by setting control word bit 4, feed hold via control word bit 5 and an edge at control word bit 6. Further positioning commands can then be controlled via control word bit 13.

If bit 13 is set, changes to the reference position, positioning velocity or positioning acceleration lead directly to a new driving job.

If bit 13 is not set, a new driving job is activated only by means of a positive or negative edge of control word bit 6.

If bit 6 in parameter 1267 (COM_DP_CtrlConfig) is set, the driving job is only activated on a positive edge. This corresponds to the last PROFIDrive profile 4.1.

If feed enable is reset while a positioning command is active, the drive is braked to a standstill on a ramp and switches to the Intermediate Stop state. The current driving job is not executed until the feed enable is set again.

A driving job can be cancelled by resetting control word bit 4.

In this case the drive is also braked to a standstill and set to the „Control active“ state. Additionally, from the initial state 5 a homing run can be triggered by control word bit 11.

7.5.1 Position control circuit and associated control parameters

Illustration 58.1 Position control loop

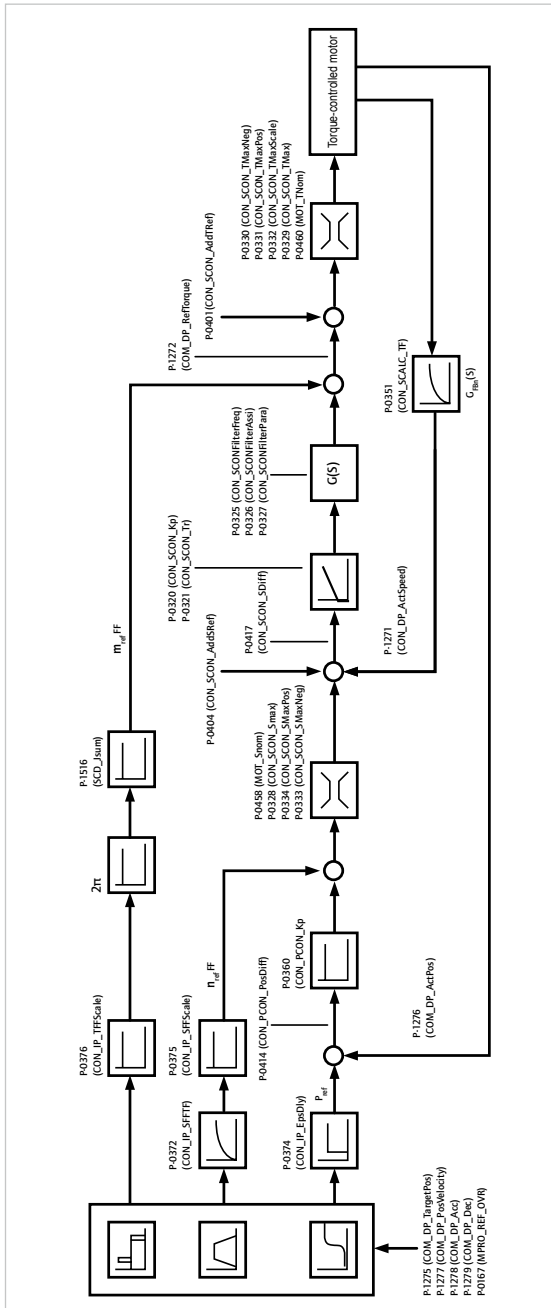

Table 59.1 Control parameters

Parameter no.	Parameter name	Meaning
P-0167	MPRO_REF_OVR	Velocity override
P-0320	CON_SCON_Kp	PI speed controller gain
P-0321	CON_SCON_Tn	PI speed controller integral-action time
P-0325	CON_SCONFilterFreq	Limit frequencies for torque reference value filter
P-0326	CON_SCONFilterAssi	Torque reference value filter parameter
P-0327	CON_SCONFilterPara	Torque reference value filter parameter
P-0328	CON_SCON_Smax	Speed limitation
P-0330	CON_SCON_TMaxNeg	Negative torque limit (reference variable: nominal torque)
P-0331	CON_SCON_TMaxPos	Positive torque limit (reference variable: nominal torque)
P-0332	CON_SCON_TMaxScale	Torque scaling factor
P-0333	CON_SCON_SMaxNeg	Negative speed limitation (reference value: motor nominal speed)
P-0334	CON_SCON_SMaxPos	Positive speed limitation (reference value: motor nominal speed)
P-0339	CON_SCON_Tmax	Torque limitation (reference value: nominal torque)
P-0351	CON_SCALC_TF	Actual speed filter time constant
P-0360	CON_PCON_Kp	Position controller gain
P-0372	CON_IP_SFFTF	Speed pre-control filter time constant
P-0374	CON_IP_EpsDly	Position reference delay
P-0375	CON_IP_SFFScale	Speed pre-control scaling
P-0376	CON_IP_TFFScale	Acceleration pre-control scaling
P-0379	CON_IP_FFMode	Configuration of pre-control
P-0401	CON_SCON_AddTRef	Additive torque reference
P-0402	CON_SCON_AddSRef	Additive velocity reference
P-0414	CON_PCON_PosDiff	Position controller control difference (tracking error)
P-0417	CON_SCON_SDiff	Speed controller differential
P-0460	MOT_TNom	Motor nominal torque
P-0458	MOT_Snom	Motor nominal speed
P-1270	COM_DP_RefSpeed	Velocity reference
P-1271	COM_DP_ActSpeed	Actual speed
P-1272	COM_DP_RefTorque	Torque reference
P-1274	COM_DP_RefPos	Reference position
P-1275	COM_DP_TargetPos	Target position
P-1276	COM_DP_ActPos1	Current actual position
P-1277	COM_DP_PosVelocity	Positioning velocity
P-1278	COM_DP_Acc	Acceleration ramp
P-1279	COM_DP_Dec	Deceleration ramp
P-1516	SCD_Jsum	Overall mass moment of inertia

7.6 Homing

7.6.1 Drive-controlled homing

Drive-controlled homing is activated with a rising edge of bit 11 in the master control word. A falling edge aborts an incomplete homing run. The completed homing is indicated in the status word by bit 11 being set.

Homing is executed according to the settings as described in the following subsections.

If the drive is run in interpolating mode, parameter 300 (CON_CfgCon) is switched from interpolating mode (IP) to profile-generating mode.

7.6.2 Homing velocity

The homing velocity is specified by parameter 2262 (MPRO_402_HomingSpeeds) in the parameter editor [Parameter list ⇒ Motion Profile ⇒ Homing]. The user can specify two different homing velocities.

1. SpeedSwitch = Velocity when moving to the limit switch
2. SpeedZero = Velocity when moving to the zero point

7.6.3 Homing acceleration

Homing acceleration is set via parameter 2263 (MPRO_402_Homing-Acc) in the parameter editor [Parameter list ⇒ Motion Profile ⇒ Homing].

7.6.4 Zero point offset

Absolute encoders (e. g. SSI-Multiturn encoders) are a special feature in homing, because they establish the absolute position reference directly. Homing with these encoders therefore requires no movement and, under certain conditions, no current to the drive. Furthermore, the zero point must be balanced. Type (-5) is particularly suitable for this. A zero point offset can be set via parameter 525 (ENC_HomingOff) [Parameter list ⇒ Motion Profile ⇒ Homing].

7.6.5 Homing method

The reference cam signal can be optionally linked to one of the digital inputs. Inputs ISD00 to ISD06 are available.

For homing to a limit switch, the digital input must be set with the available selection parameter LCW(5) for a positive or LCCW(6) negative limit switch. For homing to a cam, the selection parameter HOMSW(10) must be chosen (see parameters P 0101 -P 0107).

7.6.6 Reference cam, limit switch

The homing method is selected by parameter 2261 (MPRO_402_HomingMethod)
[Parameter list⇒Motion Profile⇒Homing].

8. Examples of commissioning with manufacturer-specific telegrams

8.1 Position control with PPO 5

The following section describes how the drive can be quickly and easily commissioned in position control mode.

First embed GSD file „LUST0A33.gsd“ in the PROFIBUS configuration phase and then select PPO type 5. PPO type 5 consists of a PKW channel (8 bytes) and 10 process data channels (20 bytes). The process data area can be freely configured using this manufacturer-specific telegram. That means that the desired reference and actual values can be mapped to a defined process data area. All mappable signals are listed in two signal tables, which can be accessed using the parameter editor under the folder Parameter list ⇨ Fieldbus ⇨ PROFIBUS-DP in the left-hand tree structure of the user interface. In this folder, signal list 1284 (COM_DP_SignalList_Write) contains all possible writeable process data signals and signal list 1285 (DP_SignalList_Read) contains all possible readable process data signals.

The user can assign the process data channels freely as required. The actual assignment takes place in signal tables 915 and 916 [Parameter list ⇨ Fieldbus ⇨ PROFIBUS-DP]. Signal table 915 (COM_DP_PZDSelectionWrite) contains all signals that can be sent by the control master to the drive. Signal table 916 (COM_DP_PZDSelectionRead) contains all signals that can be sent by the drive to the control master.

The following table shows an example configuration of the process data area from the master to the drive. The subindices in list 915 are assigned the stated parameter numbers for the purpose.

Table 62.1 Example of assignment of the master-slave process data channel

Signal table 915 Subindex	PZD area	Parameter number	Parameter name	Data type (value range)
0	1	967	Control word (COM_DP_Controlword)	U16 (0..65535)
1	2	1275	Target position (COM_DP_TargetPos)	132
2	3	1275	Target position (COM_DP_TargetPos)	(-2147483648 .. 2147483647)
3	4	1280	Control word 2 (COM_DP_Controlword2)	U16 (0..65535)
4	5	1277	Positioning velocity (COM_DP_PosVelocity)	132
5	6	1277	Positioning velocity (COM_DP_PosVelocity)	(-2147483648 .. 2147483647)
6	7	1278	Acceleration (COM_DP_Acc)	U16 (0..65535)
7	8	1279	Braking deceleration (COM_DP_Dec)	U16 (0..65535)
8	9	0	-	-
9	10	0	-	-

Each subindex represents a 16-bit process data channel. For this reason, the target position transferred as Int32, for example, is mapped to subindices 1 and 2 in order to transfer a real 32 bits.

The configuration of the process data channels can be freely selected by the user in the sequence of the signal assignments. Compliance with the data type format must be ensured however.

The following table shows an example of the process data area from the drive to the master. The subindices in list 916 are assigned the desired parameter numbers for the purpose.

Table 63.1 Example of assignment of the slave-master process data channels

Signaltab. 915 Subindex	PZD area	Parameter number	Parameter name	Data type (value range)
0	1	968	Status word (COM_DP_Statuswort)	U16 (0..65535)
1	2	1276	Actual position (COM_DP_ActPos1)	l32 (-2147483648
2	3	1276	Actual position (COM_DP_ActPos1)	.. 2147483647)
3	4	1281	Status word 2 (COM_DP_Statusword2)	U16 (0..65535)
4	5	1271	Actual velocity (COM_DP_ActSpeed)	l16 (-32768..32767)
5	6	-	-	-
6	7	-	-	-
7	8	-	-	-
8	9	-	-	-
9	10	-	-	-

The following parameters must then be set for position control mode

1. CON_CfgCon (300) : PCON(3)

[Parameter list ⇨ Motor control]

This parameter is used to change operation mode. The setting PCON (Position Control Mode) means that the drive is in position control mode.

2. CON_REF_Mode (301) : RFG(0)

[Parameter list ⇨ Motion Profile ⇨ Basic settings]

This parameter is used to set the position reference input mode. The position reference value can be preset directly or via a ramp generator. The setting RFG (Ramp Function Generator) means that the position reference value is preset via a ramp generator.

3. MPRO_CTRL_SEL (159) : PROFIBUS(7)

[Parameter List ⇨ Motion Profile ⇨ Basic settings]

This parameter is used to set the control location. In this instance the control location is selected as PROFIBUS.

4. MPRO_REF_SEL (165) : PROFI(9)

[Parameter list ⇨ Motion Profile ⇨ Basic settings]

This parameter is used to configure the reference selector. In this instance the reference values are taken from PROFIBUS. Once these settings have been made, communication can be established between the master and drive.

8.2 Control based homing

The touchprobe function enables a control based homing of an axis. In this variant the drive remains in interpolating mode. The touchprobe function is used to record the position of the reference pulse. For more information on the touchprobe function refer to the Device Help in the Touchprobe chapter.

8.3 Conversion of reference and actual values via the factor group parameters

In positioning applications the input of reference values and the return of actual values is usually performed in application-specific user units (mm, degrees, ...). The reference and actual values of the drive are converted with the so-called factor group parameters [Parameter list \leftrightarrow Motion profile \leftrightarrow Standardisation/units]. Users can choose between three different groups of parameters. All three groups have the same task, which is to convert the user units to the fixed internal variables of the servocontroller. The first factor group is based on the DSP402 standard. The parameters of this group are described in detail in the CANopen specification DSP402. The second factor group is under the heading „Sercos“. The parameters of this group refer to the Sercos specification „SERCOS interface“ (Version 2.4 / February 2005). The parameters of this group are also described in detail in the cited specification. The third factor group is called „user spec“ and is user-specific group. Since this factor group is not described in detail elsewhere, use of parameters of this group is illustrated in the following by means of an example.

Table 64.1 Parameter

Parameter no.	Parameter name	Meaning
283	MPRO_FG_Type	Factor group selection (0) = STD/402 (1) = SERCOS (2) = USER

The user can select the factor group using the parameter „MPRO_FG_Type“.

Table 64.2 Factor group USER

Parameter no.	Parameter name	Meaning	Unit
270	MPRO_FG_PosNorm	Sensor resolution	[incr/rev]
271	MPRO_FG_Num	Numerator (position)	[rev]
272	MPRO_FG_Den	Denominator (position)	[POS]
274	MPRO_FG_SpeedFac	Velocity factor	[rev/(min*SPEED)]
275	MPRO_FG_AccFac	Acceleration factor	[rev/(sec*sec*ACC)]
284	MPRO_FG_PosUnit	Position unit	String
285	MPRO_FG_PosExp	Position exponent	-
286	MPRO_FG_PosScaleFac	Position factor	-
287	MPRO_FG_SpeedUnit	Velocity unit	String
288	MPRO_FG_SpeedExp	Velocity exponent	-
289	MPRO_FG_SpeedScaleFac	Velocity factor	-

Table 65.1 Factor group USER, continuation

Parameter no.	Parameter name	Meaning	Unit
290	MPRO_FG_AccUnit	Acceleration unit	String
291	MPRO_FG_AccExp	Acceleration exponent	-
292	MPRO_FG_AccScaleFac	Acceleration factor	-
293	MPRO_FG_TorqueUnit	Torque unit	String
294	MPRO_FG_TorqueExp	Torque exponent	-
295	MPRO_FG_TorqueScaleFac	Torque factor	-

These define the internal resolution of the unit for:

Position: rev

Velocity: rev/min

Acceleration: rev/(sec*sec)

The units are automatically defined by the profiles themselves when selecting DSP402 or Sercos. When selecting USER, the units can be defined manually.

The parameters for unit and exponent refer to the display and have no effect on the standardisation of the variables themselves.

The following three formulae describe the conversion of user units into the units used internally in positioning mode. They refer to reference position, velocity and acceleration.

Reference position

$$\text{Reference position}_{\text{Intern}} [\text{rev}] = \text{COM_DP_REFPos} [\text{User unit}] \cdot \frac{\text{MPRO_FG_Num} [\text{rev}]}{\text{MPRO_FG_Den} [\text{User unit}]}$$

The quotient of parameters MPRO_FG_Num and MPRO_FG_Den describes the ratio of user unit to motor revolutions. It also allows any gear ratios or feed constants to be incorporated.

Positioning velocity

$$\text{Positioning speed}_{\text{Intern}} \frac{[\text{rev}]}{[\text{min}]} = \text{COM_DP_REFSpeed} [\text{User unit}] \cdot \text{MPRO_FG_SpeedFac} \frac{[\text{rev}]}{[\text{Min} \cdot \text{User unit}]}$$

The parameter MPRO_FG_SpeedFac offers the facility to change the number of decimal points for the positioning velocity or the unit of positioning velocity.

Positioning acceleration:

$$\text{Positioning speed}_{\text{Intern}} \frac{[\text{rev}]}{[\text{sec}^2]} = \text{COM_DP_Acc} [\text{User unit}] \cdot \text{MPRO_FG_AccFac} \frac{[\text{rev}]}{[\text{sec}^2 \cdot \text{User unit}]}$$

The parameter MPRO_FG_AccFac offers the facility to change the number of decimal points for the positioning acceleration or the unit of positioning acceleration.

8.4 Examples for setting the user factor group

The positioning instructions should be input in degrees, so that 360° corresponds to one revolution of the motor (655 36 increments per revolution of the motor). The velocity should be preset in revs per minute (rev) and the acceleration in rev/sec. This gives the following values:

```
P00270 Encoder resolution      = 65536 [incr/rev]
P00271 Position numerator     = 1 [rev]
P00272 Position denominator  = 360 [POS] **
P00274 Velocity factor       = 1 [rev/(min*SPEED)] ***
P00275 Acceleration factor    = 1/60 [rev /(sec*sec*ACC)] ****
P00284 Position unit (string) = „Degree“
P00287 Velocity unit (string) = „1/min“
P00290 Acceleration unit (string) = „1/(min*sec)“
```

** POS = User unit for position

***SPEED = User unit for velocity

****ACC = User unit for acceleration

8.5 Speed control with PPO 2

The following section describes how the drive can be quickly and easily commissioned in speed control mode. First embed GSD file „LUST0A33.gsd“ in the PROFIBUS configuration phase and then select PPO type 2.

PPO type 2 consists of a PKW channel (8 bytes) and six process data channels (12 bytes). The process data area can be freely configured using this manufacturer-specific telegram. That means that the desired reference and actual values can be mapped to a defined process data area. All mappable signals are listed in two signal tables, which can be accessed using the parameter editor under the folder Parameter list ⇒ Fieldbus ⇒ PROFIBUS-DP in the left-hand tree structure of the user interface. In this folder, signal list 1284 (COM_DP_SignalList_Write) contains all possible writeable process data signals and signal list 1285 (DP_SignalList_Read) contains all possible readable process data signals.

The user can freely assign the process data area. The actual assignment takes place in signal tables 915 and 916 (Parameter list ⇒ Fieldbus ⇒ PROFIBUSDP). Signal table 915 (COM_DP_PZDSelectionWrite) contains all signals that can be sent by the control master to the drive. Signal table 916 (COM_DP_PZDSelectionRead) contains all signals that can be sent by the drive to the control master.

The following table shows an example of the process data area from the master to the drive. The subindices in list 915 are assigned the desired parameter numbers for the purpose.

Table 671 Assignment of the master-slave process data channels

Signal table 915 Subindex	PZD area	Parameter number	Parameter name	Data type (value range)
0	1	967	Control word (COM_DP_Controlword)	U16 (0..65535)
1	2	1270	Reference speed (COM_DP_RefSpeed)	I16 (-32768..32767)
2	3	1278	Acceleration (COM_DP_Acc)	U16 (0..65535)
3	4	1279	Braking deceleration (COM_DP_Dec)	U16 (0..65535)
4	5	-	-	-
5	6	-	-	-
6	7	-	-	-
7	8	-	-	-
8	9	-	-	-
9	10	-	-	-

Each subindex represents a 16-bit process data channel. For this reason, an Int32 parameter, for example, must be mapped to two subindices.

The configuration of the process data areas can be freely selected by the user in the sequence of the signal assignments. The only requirement is compliance with the data type format. That means that a 32-bit variable also accordingly requires two process data channels.

The following table shows an example of the process data area from the drive to the master. The subindices in list 916 are assigned the desired parameter numbers for the purpose.

Table 672 Assignment of the slave-master process data channels

Signal tab. 915 Subindex	PZD area	Parameter number	Parameter name	Data type (value range)
0	1	968	Status word (COM_DP_Statuswort)	U16 (0..65535)
1	2	1271	Actual speed (COM_DP_ActSpeed)	I16 (-32768..32767)
2	3	-	-	-
3	4	-	-	-
4	5	-	-	-
5	6	-	-	-
6	7	-	-	-
7	8	-	-	-
8	9	-	-	-
9	10	-	-	-

The following parameters must then be set for speed control mode:

1. CON_CfgCon (300) : SCON(2) [Parameter list ⇨ control]
This parameter is used to change operation mode. The setting SCON (Speed Control Mode) means that the drive is in speed control mode.
2. CON_REF_Mode (301) : RFG(0) [Parameter list ⇨ Motion Profile ⇨ Basic settings]
This parameter determines the mode of reference input. The position reference value can be preset directly or via a ramp generator. The setting RFG (Ramp Function Generator) means that the speed reference value is preset via a ramp generator.
3. MPRO_CTRL_SEL (159) : PROFIBUS(7) [Parameter list ⇨ Motion Profile ⇨ Basic settings]
This parameter is used to set the control location. In this instance the control location is PROFIBUS.
4. MPRO_REF_SEL (165) : PROFI(9) [Parameter list ⇨ Motion Profile ⇨ Basic settings]
This parameter is used to configure the reference selector. In this instance the reference values are taken from PROFIBUS.

8.5.1 Speed input

All factor group parameters are set to default values. The speed reference value can then be preset scaled to the motor rated speed. So a value of 16384 corresponds to a speed reference value of 100 % of the motor rated speed.

The drive can then be operated in speed control mode using the control word.

8.6 Mappable parameters

Table 69.1 Mappable parameters

Parameter no.	Parameter name	Write (1284)	Read (1285)	PZD Length
967	COM_DP_Controlword	X	X	1
968	COM_DP_Statusword	-	X	1
1280	COM_DP_Controlword2	X	X	1
1281	COM_DP_Statusword2	-	X	1
1270	COM_DP_RefSpeed	X	X	1
1271	COM_DP_ActSpeed	-	X	1
121	MPRO_Input_State	-	X	1
143	MPRO_Output_State	-	X	1
1274	COM_DP_RefPos	X	X	2
1276	COM_DP_ActPos1	-	X	2
207	MPRO_TAB_ActIdx	X	X	1
1275	COM_DP_TargetPos	X	X	2
1277	COM_DP_PosVelocity	X	X	2
1278	COM_DP_Acc	X	X	1
1279	COM_DP_Dec	X	X	1
1287	COM_DP_TMaxPos	X	X	1
1288	COM_DP_TMaxNeg	X	X	1

Further mappable parameters can be found in signal tables 1284 (COM_DP_Signal-List_Write) and 1285 (DP_SignalList_Read) [Parameter List ⇒ Fieldbus ⇒ PROFIBUS-DP].

9. PROFIBUS/PROFINET parameters

The following table describes the available parameters.

Table 70.1 PROFIBUS and PROFINET parameters

Parameter name	Number	Value range	Default value	Changeable	Data type	Meaning
COM_DP_PZDSelectionWrite	P 0915	0 - 65535	967	Yes	U16	This parameter allows incoming process data to be linked to specific device parameters. Parameter 1284 indicates which parameters can be entered. Subindex 0 contains the first process data word PZD1, etc.
COM_DP_PZDSelectionRead	P 0916	0 - 65535	968	Yes	U16	This parameter allows outgoing process data to be linked to specific device parameters. Parameter 1285 indicates which parameters can be entered. Subindex 0 contains the first process data word PZD1, etc.
COM_DP_Address*	P 0918	0 - 126	126	Yes	U16	Station address of the inverter
COM_DP_TelegramSelection	P 0922	0 - 65535	0	Yes	U16	Selection of process data telegram
COM_DP_SignalList	P 0923	0 - 65535	0	No	U16	This parameter lists all mappable parameters and signals for parameters 915 and 916.
COM_PN_sign_of_life_limit	P 0925	0 - 65535	0	Yes	U16	Number of approved SOL (Sign of Life) errors until error shutdown Type U16: 0x0000 ... 0xFFE 0xFFFF = switched off
COM_DP_Warning	P 0953	0 - 0xFFFF	0	No	U16	This parameter returns warning messages from PROFIBUS. These include bus timeout and PLC stop mode.
COM_DP_Baudrate*	P 0963	9.6 - 45.45 kbits/s	9.6 kbit/s	No	U16	Current Baud rate for bus communication
COM_DP_DeviceId	P 0964	0 - 65535	0	No	U16	This parameter is for device identification
COM_DP_Profile No.	P 0965	0 - 65535	0	No	U16	Profile number, not supported in the first step

* PROFIBUS parameters only

Table 71.1 PROFIBUS and PROFINET parameters, continuation

Parameter name	Number	Value range	Default value	Changeable	Data type	Meaning
COM_DP_Controlword	P 0967	0 - 0xFFFF	0	Yes	U16	Control word for the internal state machine
COM_DP_Statusword	P 0968	0 - 0xFFFF	0	No	U16	Status word for the internal state machine
COM_DP_DataStore	P 0971	0 - 255	0	Yes	U16	This parameter permits storage of data in the non-volatile memory.
COM_DP_DefinedParameter	P 0980	0 - 65535	0	No	U16	This parameter describes the defined parameters in the drive controller
COM_DP_ModifiedParameter	P 0990	0 - 65535	0	No	U16	This parameter describes all the parameters in the drive controller that are not set to the default values.
COM_DP_CtrlConfig	P 1267	0 - 65535	0	Yes	U16	This parameter describes the function of each bits in the control word, parameter 967.
COM_DP_RefJogSpeed1	P 1268	- 4294967296 - 4294967295	0	Yes	I32	This parameter contains the reference velocity 1 in jog mode
COM_DP_RefJogSpeed2	P 1269	- 4294967296 - 4294967295	0	Yes	I32	This parameter contains the reference velocity 2 in jog mode
COM_DP_RefSpeed	P 1270	-32768 - 32767	0	Yes	I16	Speed reference value written via PROFIBUS

Table 72.1 PROFIBUS and PROFINET parameters, continuation

Parameter name	Number	Value range	Default value	Changeable	Data type	Meaning
COM_DP_ActSpeed	P 1271	-32768 - 32767	0	No	I16	Actual speed
COM_DP_RefTorque	P 1272	-32768 - 32767	0	Yes	I16	Torque reference value written via PROFIBUS
COM_DP_ActTorque	P 1273	-32768 - 32767	0	No	I16	Actual torque
COM_DP_RefPos	P 1274	-2147483648 - 2147483647	0	Yes	I32	Position reference value (ramp mode) written via PROFIBUS
COM_DP_TargetPos	P 1275	-2147483648 - 2147483647	0	Yes	I32	Position reference value (direct mode) written via PROFIBUS
COM_DP_ActPos1	P 1276	-2147483648 - 2147483647	0	No	I32	Actual position of 1st position encoder
COM_DP_PosVelocity	P 1277	-2147483648 - 2147483647	0	Yes	I32	Velocity reference value (ramp mode) written via PROFIBUS
COM_DP_Acc	P 1278	0 - 0xFFFF	100	Yes	U16	Acceleration reference value (ramp mode) written via PROFIBUS
COM_DP_Dec	P 1279	0 - 0xFFFF	100	Yes	U16	Deceleration reference value (ramp mode) written via PROFIBUS
COM_DP_Controlword2	P 1280	0 - 0xFFFF	0	Yes	U16	2nd control value, not used at first
COM_DP_Statusword2	P 1281	0 - 0xFFFF	0	No	U16	2nd control word, initially not used
COM_DP_Bus_Timeout	P 1283	0 - 4294967295	5000	Yes	U32	Bus timeout
COM_DP_SignalList_write	P 1284	0 - 65535	0	No	U16	List of parameters that can be used as process data reference values
COM_DP_SignalList_Read	P 1285	0 - 65535	0	No	U16	List of parameters that can be used as process data actual values
COM_DP_TMaxScale	P 1286	0 - 2000	1000	Yes	U16	Online torque scaling
COM_DP_TMaxPos	P 1287	0 - 2000	1000	Yes	U16	Positive online torque scaling
COM_DP_TMaxNeg	P 1288	0 - 2000	1000	Yes	U16	Negative online torque scaling

Table 73.1 PROFIBUS and PROFINET parameters

Parameter name	Number	Value range	Default value	Changeable	Data type	Meaning
COM_PN_StationName	P 1289		DRIVE	Yes	string	Station name of PROFINET device
COM_PN_StationIP	P 1290	0-FFFFFFF	0	No	U32	IP address of PROFINET device
COM_PN_StationSubnet	P 1291	0-FFFFFFF	0	No	U32	Subnet mask of PROFINET device
COM_PN_StationMAc	P 1292	[0] -[5] 0-FF	0	No	U8	Station MAC address of PROFINET device
COM_PN_StationMAc	P 1292	[6] -[11] 0-FF	0	No	U8	Station MAC address of PROFINET device
COM_PN_StationMAc	P 1292	[12] -[17] 0-FF	0	No	U8	Station MAC address of PROFINET device
COM_PN_ProductFamily	P 1293		DRIVE	No	string	Product family
COM_PN_IM	P 1294	0-FFFF	0	No	U16	Identification and maintenance data (IM)
COM_PN_DefaultGateway	P 1295	0-FFFFFFF	0	No	U32	Gateway (factory setting)
COM_PN_Sign_of_life_err_cnt	P 1296	0-65535	0	No	U16	Display of current error counter

Parameter 1294 is based on the description of the standard - Profile Guidelines Part 1: Identification & Maintenance Functions, 1.2, Oct 2009, Order no. 3.502 for I & M record 0.

10. Appendix

10.1 General

AK

Request identifier

Application data set

Factory pre-defined data set for solution of typical applications

Diagnostic data

The master reads the diagnostic data from the slave and so permits a centralised response to slave malfunctions.

DP

Distributed peripherals

Master

The master controller which handles communication.

MW

Flag word

Parameter data

The PKW parameter channel is used to transfer parameters cyclically to and from the drive device.

PKW

Parameter identifier value

PNU

Parameter number

ProfiDrive Mode

Configuration of the process data channel, conforming to the PROFIdrive profile. In contrast to EasyDrive mode, the system states are changed by defined control sequences. The system state machine defined in the PROFIBUS standard specifies the individual system state transitions.

PZD

Process data: The process data channel contains the functions „Apply control and status“, „Input reference values“ and „Display actual values“.

Slave

A slave is a station on the PROFIBUS-DP bus which, in contrast to the master, responds only to the requests directed to it.

SPM

Spontaneous message

State machine

This describes the transitions between the various system states. A state transition is triggered by a defined event such as a control sequence or the setting of an input.

10.2 Technical data

The PROFIBUS/PROFINET implementation in ServoOne conforms to the PROFIdrive profile „PROFIBUS PROFIdrive-Profile Version 4.0“ dated August 2005. The profile is not implemented in full however

Table 75.1

	PROFIBUS	PROFINET
Data transfer	Two-wire cable (RS485)	Standard Ethernet patch cable (e.g. 5/ FTP Cat. 5e)
Max. transfer rate	12 MBaud	100 MBaud
Automatic baud rate detection	Yes	Fixed
Max. cable length	1000 m @ 9.6 to 187.5 KBaud 400 m @ 500 KBaud 200 m @ 1.5 MBaud 100 m @ 3 to 12 Mbaud The specified PROFIBUS cables should be used (see chapter 2.1.3)	100 m when using the specified PROFIBUS cable (see chapter 2.2.3) When using standard commercially available Ethernet cables, a max. cable length of 40 m is possible.
Network topologies	Line without repeater Line and tree with repeater	Tree, star and line
Programmable PROFIBUS address	Via addressing parameter	-
Cyclic exchange of reference and actual value data	Yes, via DPV0	Yes (up to 64 bytes)
Acyclic data exchange	Yes, via DPV1	Yes
Writing and reading drive parameters	Yes, via PKW channel or DPV1	Yes
Synchronisation of all connected drives in Freeze and Sync mode	Yes	-
Field bus stations	Slave	IO device with real-time (RT) and synchronous IRT (isochronous real-time) communication
Specification		PROFINET Version 2.2 (October 2007)

...just move it!



Germany
Harmonic Drive AG
Hoenbergstraße 14
65555 Limburg/Lahn

T +49 6431 5008-0
F +49 6431 5008-119

info@harmonicdrive.de
www.harmonicdrive.de



Subject to technical changes.

06/2015 1003375